

LINEAR

COLLECTION



PANEL, CABLE AND TUBE SYSTEMS



A NOVO Building Products Company

PANEL SYSTEM

This collection consists of preassembled panels resulting in a very simplified installation process for open tread stairs, kneewall stairs and level run applications. This system is for interior use only.

Our Linear Panels can be pre-built to fit and only need a few screw holes drilled for installation. No glue needed, no sanding, no drilling of baluster holes, no marking and cutting to fit.

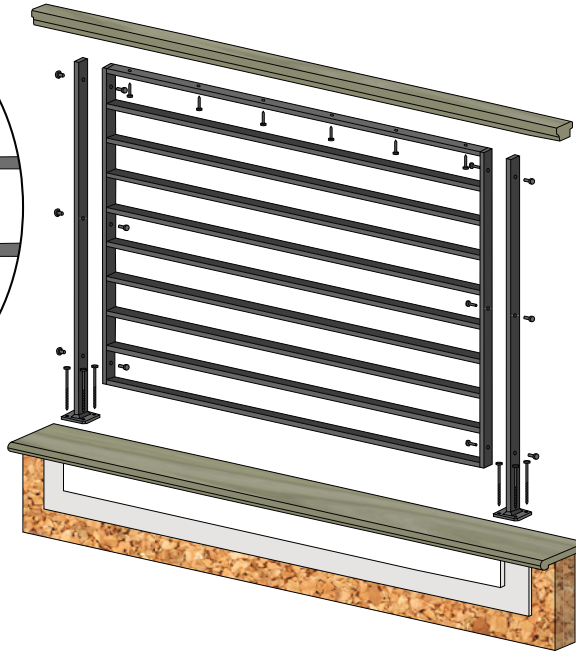
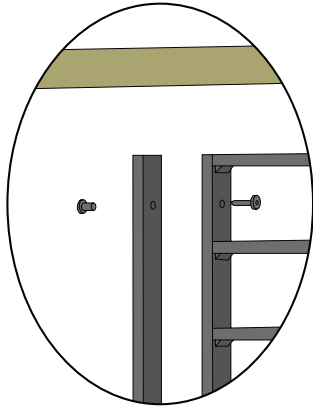

Installation Instructions are available on our website www.LJSmith.com

Installation hardware included with panels and posts:

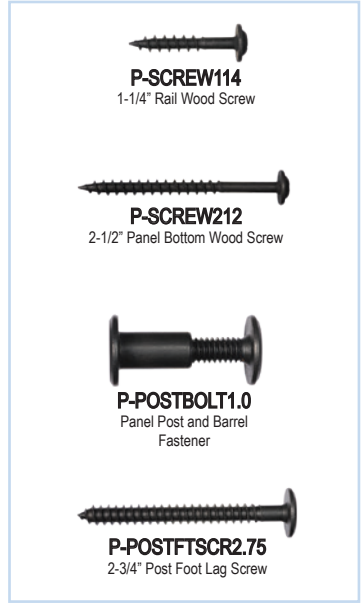

1/2" x 1 1/2" rectangular tube construction with .065 wall thickness

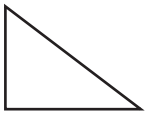

Designed for 7 1/2" Rise and 10" Run (36.9°)

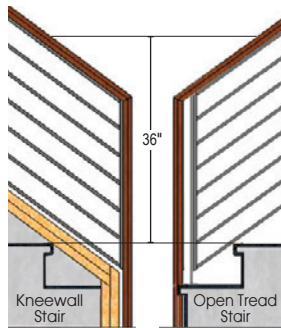

36" Rake rail height and 36", 39" or 43" level run rail heights. Rail heights may vary due to field conditions or preferences



Five rake panel widths

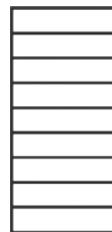

Seven level panel widths



Standard finish is Low Sheen Black. Other powder coat and Pantone paint colors can be quoted.

Kneewall Stair Panels

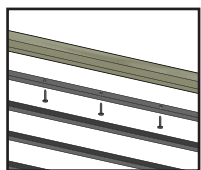

Every rake and level panel is predrilled on the top rung and comes with screws for attachment to the handrail. Screws are also included for the bottom of each panel.

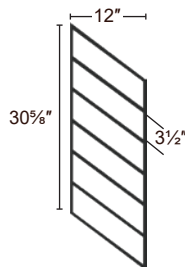

PR-K1236
15"
Actual Rake Length

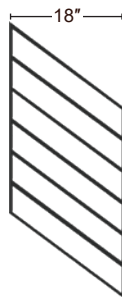

PR-K1836
22 1/2"
Actual Rake Length

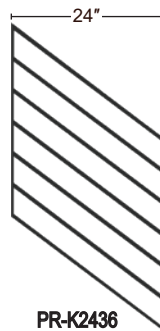

PR-K2436
30"
Actual Rake Length

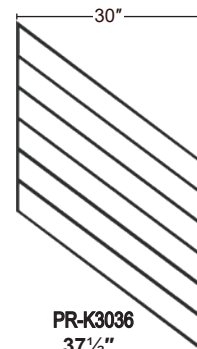

PR-K3036
37 1/2"
Actual Rake Length

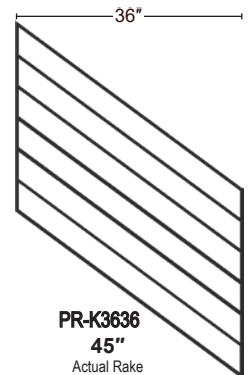

PR-K3636
45"
Actual Rake Length

Open Tread Stair Panels

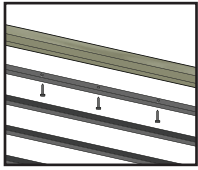

Every rake and level panel is predrilled on the top rung and comes with screws for attachment to the handrail. Screws are also included for the bottom of each panel.

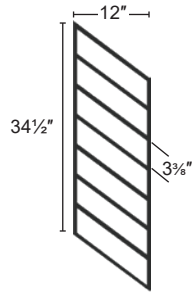

PR-O1236
15"
Actual Rake Length

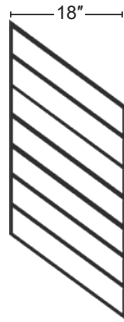

PR-O1836
22 1/2"
Actual Rake Length

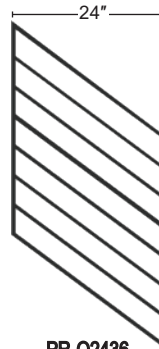

PR-O2436
30"
Actual Rake Length

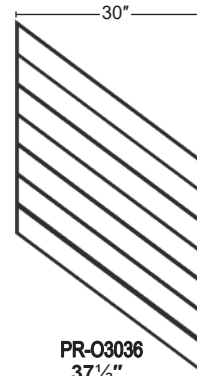

PR-O3036
37 1/2"
Actual Rake Length

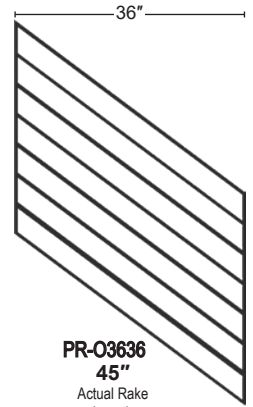

PR-O3636
45"
Actual Rake Length

Level Run Panels

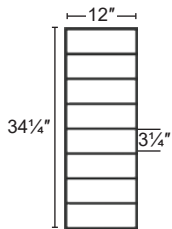

PL-CE1239
39" Rail Height
Curb Wall or Elevated



PL-CE1839
39" Rail Height
Curb Wall or Elevated



PL-CE2439
39" Rail Height
Curb Wall or Elevated

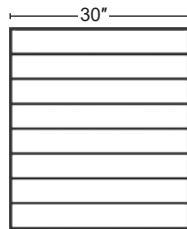

PL-CE3039
39" Rail Height
Curb Wall or Elevated

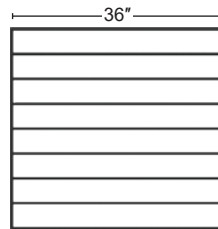

PL-CE3639
39" Rail Height
Curb Wall or Elevated

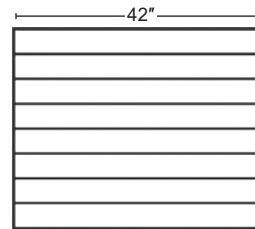

PL-CE4239
39" Rail Height
Curb Wall or Elevated

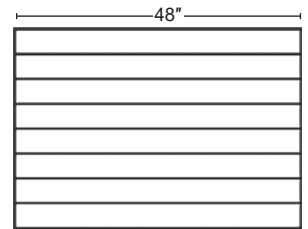

PL-CE4839
39" Rail Height
Curb Wall or Elevated

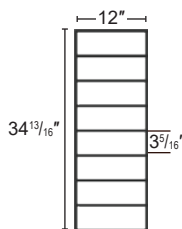

PL-F1236
36" Rail Height
Flush Mount



PL-F1836
36" Rail Height
Flush Mount



PL-F2436
36" Rail Height
Flush Mount

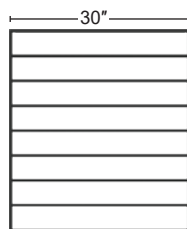

PL-F3036
36" Rail Height
Flush Mount

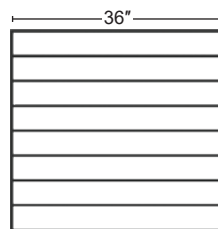

PL-F3636
36" Rail Height
Flush Mount

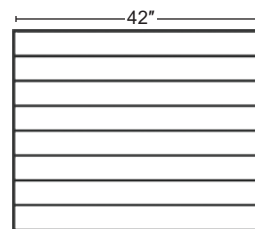

PL-F4236
36" Rail Height
Flush Mount

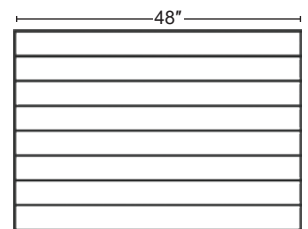

PL-F4836
36" Rail Height
Flush Mount

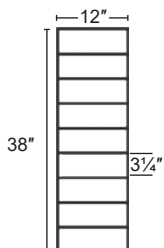

PL-CE1243
43" Rail Height
Curb Wall or Elevated



PL-CE1843
43" Rail Height
Curb Wall or Elevated



PL-CE2443
43" Rail Height
Curb Wall or Elevated



PL-CE3043
43" Rail Height
Curb Wall or Elevated

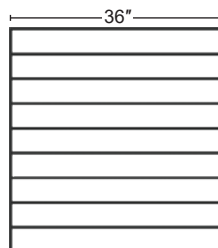

PL-CE3643
43" Rail Height
Curb Wall or Elevated

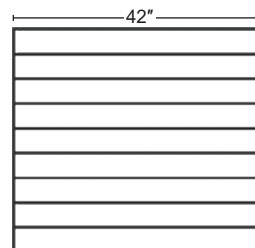

PL-CE4243
43" Rail Height
Curb Wall or Elevated

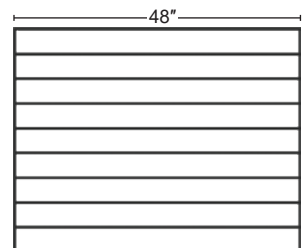

PL-CE4843
43" Rail Height
Curb Wall or Elevated

PL-F1239
39" Rail Height
Flush Mount

PL-F1839
39" Rail Height
Flush Mount

PL-F2439
39" Rail Height
Flush Mount

PL-F3039
39" Rail Height
Flush Mount

PL-F3639
39" Rail Height
Flush Mount

PL-F4239
39" Rail Height
Flush Mount

PL-F4839
39" Rail Height
Flush Mount

PANEL SYSTEM

Spacer Newels

Use to maintain spacing code between panels. Rake and Level Panel Runs cannot exceed 15' without a spacer Newel

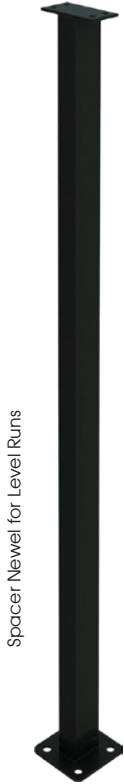

Spacer Newel for Level Runs

Level 4-Hole Foot Spacer Newel

PL-F36NWL4H
1" x 1-1/2" x 34-13/16"
36" Rail Height
Flush Mount

PL-E43NWL4H
1" x 1-1/2" x 41-1/4"
43" Rail Height
Elevated

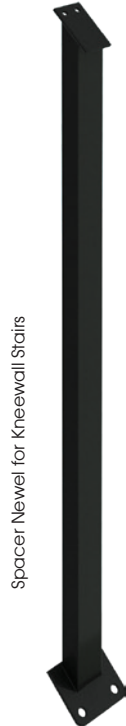

Spacer Newel for Kneewall Stairs

Kneewall 2-Hole Foot Spacer Newel

PR-K36NWL2H
1" x 1-1/2" x 30-5/8"
36" Rail Height

PL-F39NWL4H
1" x 1-1/2" x 38"
39" Rail Height
Flush Mount

PL-C39NWL4H
1" x 1-1/2" x 34-1/4"
39" Rail Height
Curb Wall

PL-E39NWL4H
1" x 1-1/2" x 37-1/2"
39" Rail Height
Elevated

PL-C43NWL4H
1" x 1-1/2" x 38"
43" Rail Height
Curb Wall

Panel Posts



Panel Post for Level Runs and Open Tread Stairs

P-POST2H
1/2" x 1-1/2" x 47"
2-Hole Foot Plate



Panel Post for Level Runs and Open Tread Stairs. Often used at the end of a level run that ends near a wall.

P-POST4H
1/2" x 1-1/2" x 47"
4-Hole Foot Plate

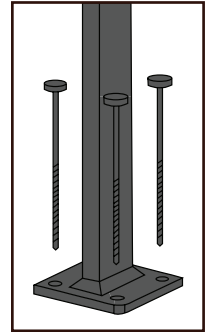

Each Spacer Newel and Panel Post comes with foot lag screws for attachment to the mounting surface. Spacer Newels also include wood screws for attachment to the handrail. Each Panel Post includes 3 Panel Post and Barrel Fasteners for attachment to the panel.



P-SCREW114
1-1/4" Rail Wood Screw



P-POSTFTSCR2.75
2-3/4" Post Foot Lag Screw



P-POSTBOLT1.0
Panel Post and Barrel Fastener

Panel Posts are used to secure panels on open tread stairs and level runs when the panels are elevated above the floor.

Panel Post Kit

The following kit is available to simplify the ordering of panel systems utilizing Panel Posts.

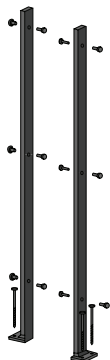

P-POSTKIT2H

- Each kit includes:
- 2 Panel Posts with 2-Hole Foot Plate (P-POST2H)
 - 4 2-3/4" Post Foot Lag Screws (P-POSTFTSCR2.75)
 - 6 Post and Barrel Bolts (P-POSTBOLT1.0)

Flush, Elevated and Curb Wall Details

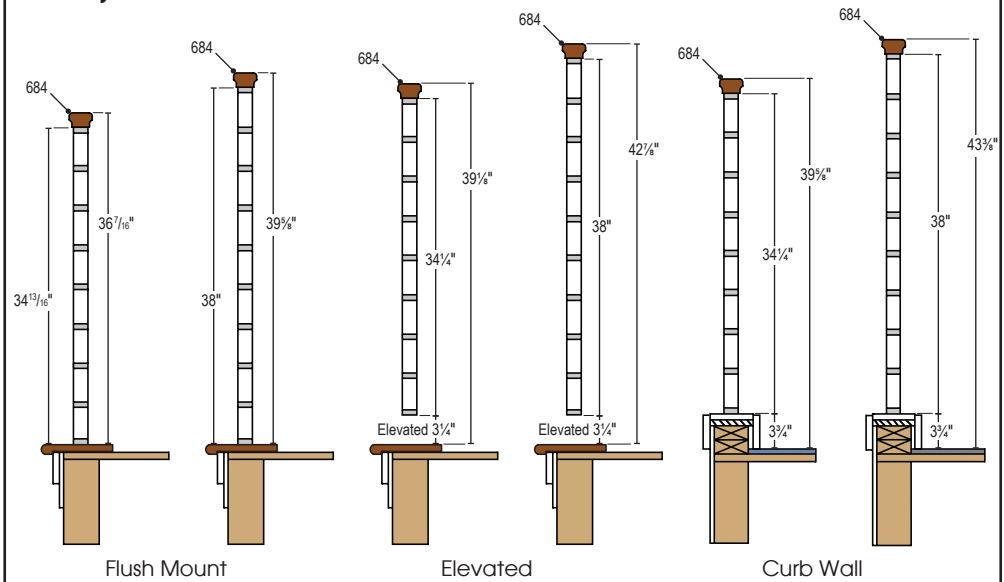

Stairway Anatomies

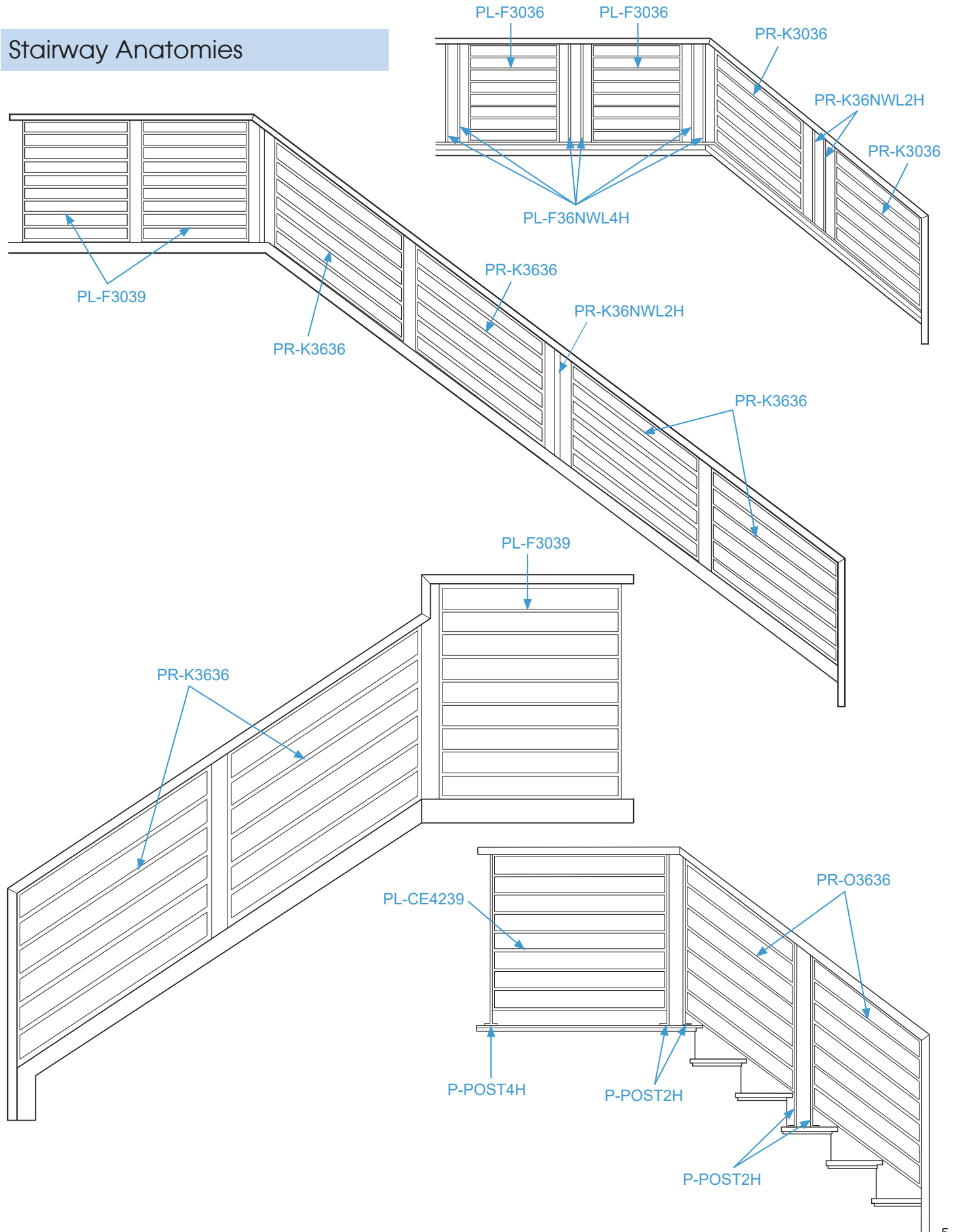

METAL NEWELS FOR CABLE SYSTEM

Stairway Open Tread Newels

Stairway Kneewall Newels

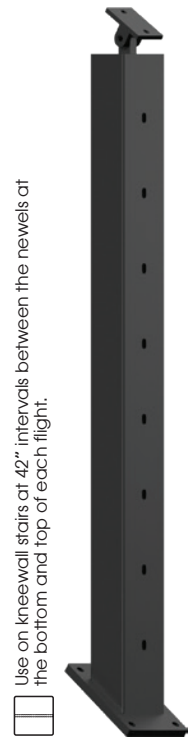
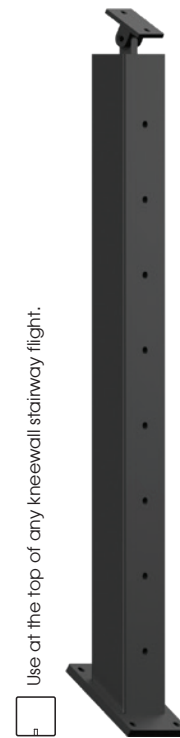
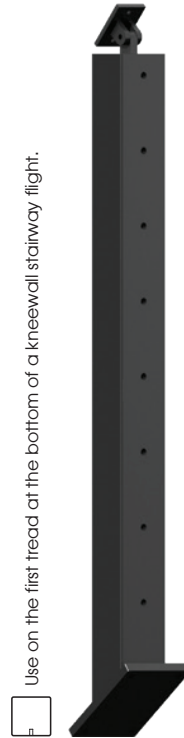
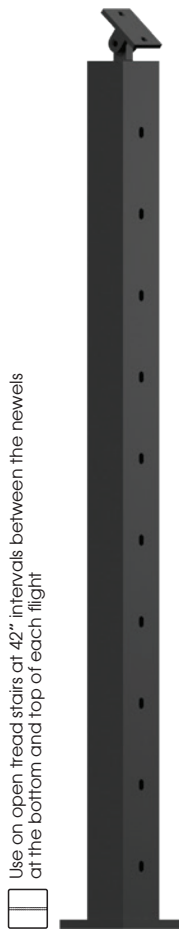
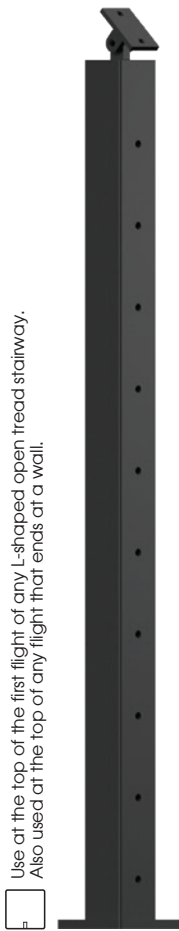
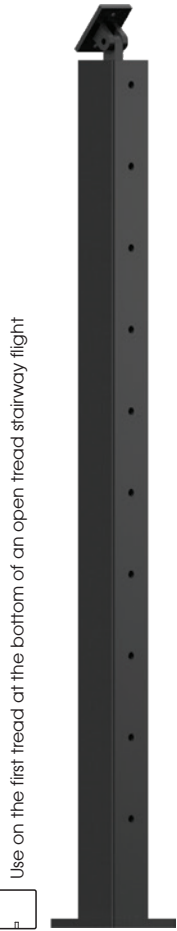

Rake Up
10 Holes **CR-310U-36**
2" x 35²¹/₃₂"
11 Holes **CR-310U-39**
2" x 38²¹/₃₂"

Rake Down
CR-310D-36
2" x 35²¹/₃₂"
CR-310D-39
2" x 38²¹/₃₂"

Rake Pass Through
CR-320-36
2" x 35²¹/₃₂"
CR-320-39
2" x 38²¹/₃₂"

Rake Up
8 Holes **CR-KW310U-36**
2" x 28⁷/₁₆"
9 Holes **CR-KW310U-39**
2" x 31⁷/₁₆"

Rake Down
CR-KW310D-36
2" x 28⁷/₁₆"
CR-KW310D-39
2" x 31⁷/₁₆"

Rake Pass Through
CR-KW320-36
2" x 28⁷/₁₆"
CR-KW320-39
2" x 31⁷/₁₆"

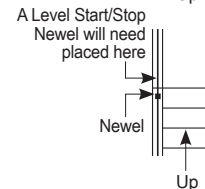
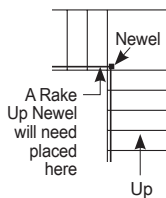
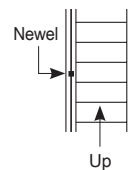
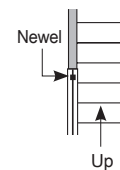
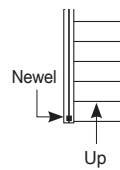
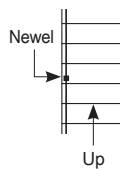
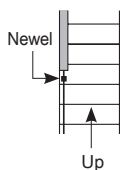
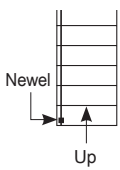

Each Metal Newel Post comes with 2 1/2" foot lag screws for attachment to the mounting surface and 1" wood screws for attachment to the handrail.

Installation Instructions are available on our website
www.LJSmith.com

See page 14 for cable, cable fittings and cable accessories. This system is for interior or exterior use.

IMPORTANT: Our Metal Newels and Cable System is designed for stairways with 7-1/2" rise and 10" run (approx. 36.9°)

Level Run Newels

Transition Newels-Rake to Level Run

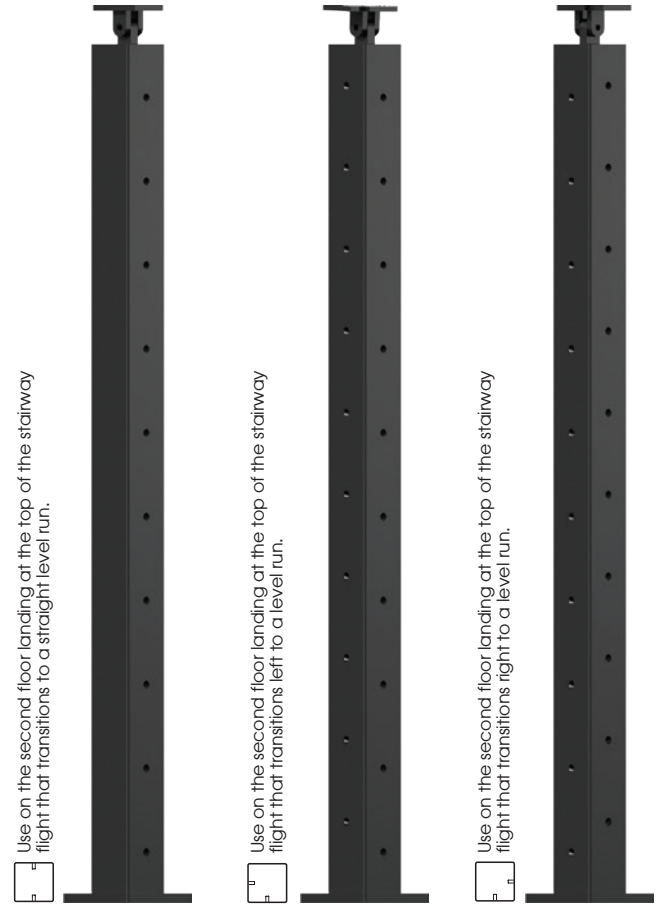
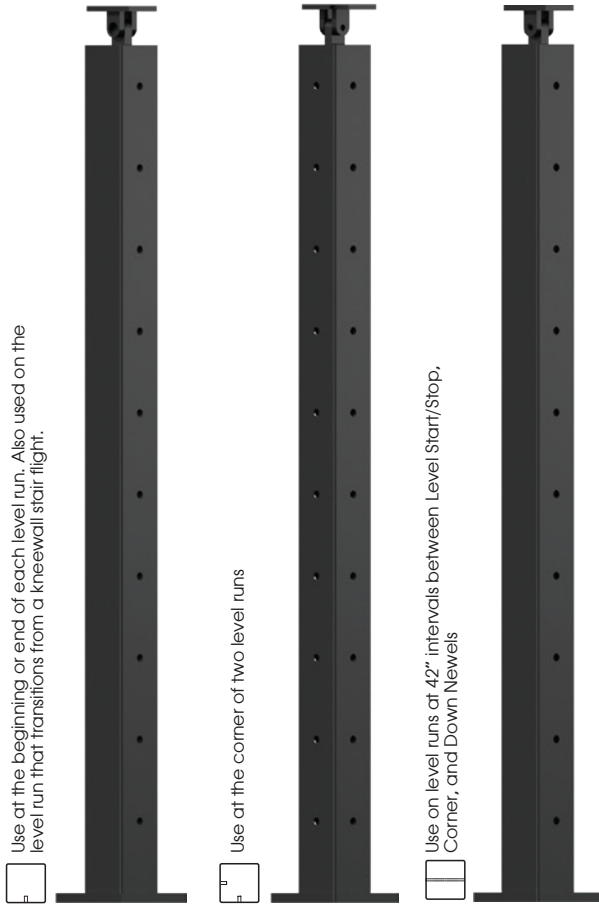

| | Level Start/Stop | Level Corner | Level Pass Through |
|----------|---|--|---|
| 10 Holes | CL-310-36 2" x 34 ³ / ₈ " | CL-310C-36 2" x 34 ³ / ₈ " | CL-320-36 2" x 34 ³ / ₈ " |
| 11 Holes | CL-310-39 2" x 37 ³ / ₈ " | CL-310C-39 2" x 37 ³ / ₈ " | CL-320-39 2" x 37 ³ / ₈ " |
| 12 Holes | CL-310-42 2" x 40 ³ / ₈ " | CL-310C-42 2" x 40 ³ / ₈ " | CL-320-42 2" x 40 ³ / ₈ " |

| | Level Down/Straight | Level Down/Left | Level Down/Right |
|-------------|---|---|---|
| 10 Holes | CL-310DS-36 36 rake to 36 level 2" x 34 ³ / ₈ " | CL-310DL-36 36 rake to 36 level 2" x 34 ³ / ₈ " | CL-310DR-36 36 rake to 36 level 2" x 34 ³ / ₈ " |
| 10&11 Holes | CL-310D36S-39* 36 rake to 39 level 2" x 37 ³ / ₈ " | CL-310D36L-39* 36 rake to 39 level 2" x 37 ³ / ₈ " | CL-310D36R-39* 36 rake to 39 level 2" x 37 ³ / ₈ " |
| 10&12 Holes | CL-310D36S-42* 36 rake to 42 level 2" x 40 ³ / ₈ " | CL-310D36L-42* 36 rake to 42 level 2" x 40 ³ / ₈ " | CL-310D36R-42* 36 rake to 42 level 2" x 40 ³ / ₈ " |
| 11 Holes | CL-310DS-39 39 rake to 39 level 2" x 37 ³ / ₈ " | CL-310DL-39 39 rake to 39 level 2" x 37 ³ / ₈ " | CL-310DR-39 39 rake to 39 level 2" x 37 ³ / ₈ " |
| 11&12 Holes | CL-310D39S-42* 39 rake to 42 level 2" x 40 ³ / ₈ " | CL-310D39L-42* 39 rake to 42 level 2" x 40 ³ / ₈ " | CL-310D39R-42* 39 rake to 42 level 2" x 40 ³ / ₈ " |

*Requires a gooseneck handrail fitting

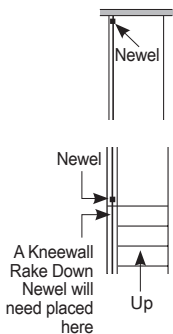

Each Metal Newel Post comes with 2 1/2" foot lag screws for attachment to the mounting surface and 1" wood screws for attachment to the handrail.

Installation Instructions are available on our website
www.LJSmith.com

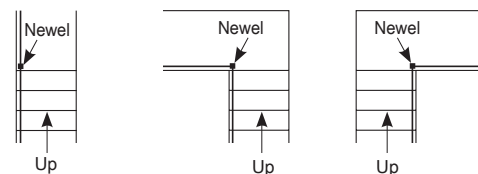

See page 14 for cable, cable fittings and cable accessories. This system is for interior or exterior use.

IMPORTANT: Our Metal Newels and Cable System is designed for stairways with 7-1/2" rise and 10" run (approx. 36.9°)

METAL NEWELS & CABLE SYSTEM

Open Tread Stairway Anatomy

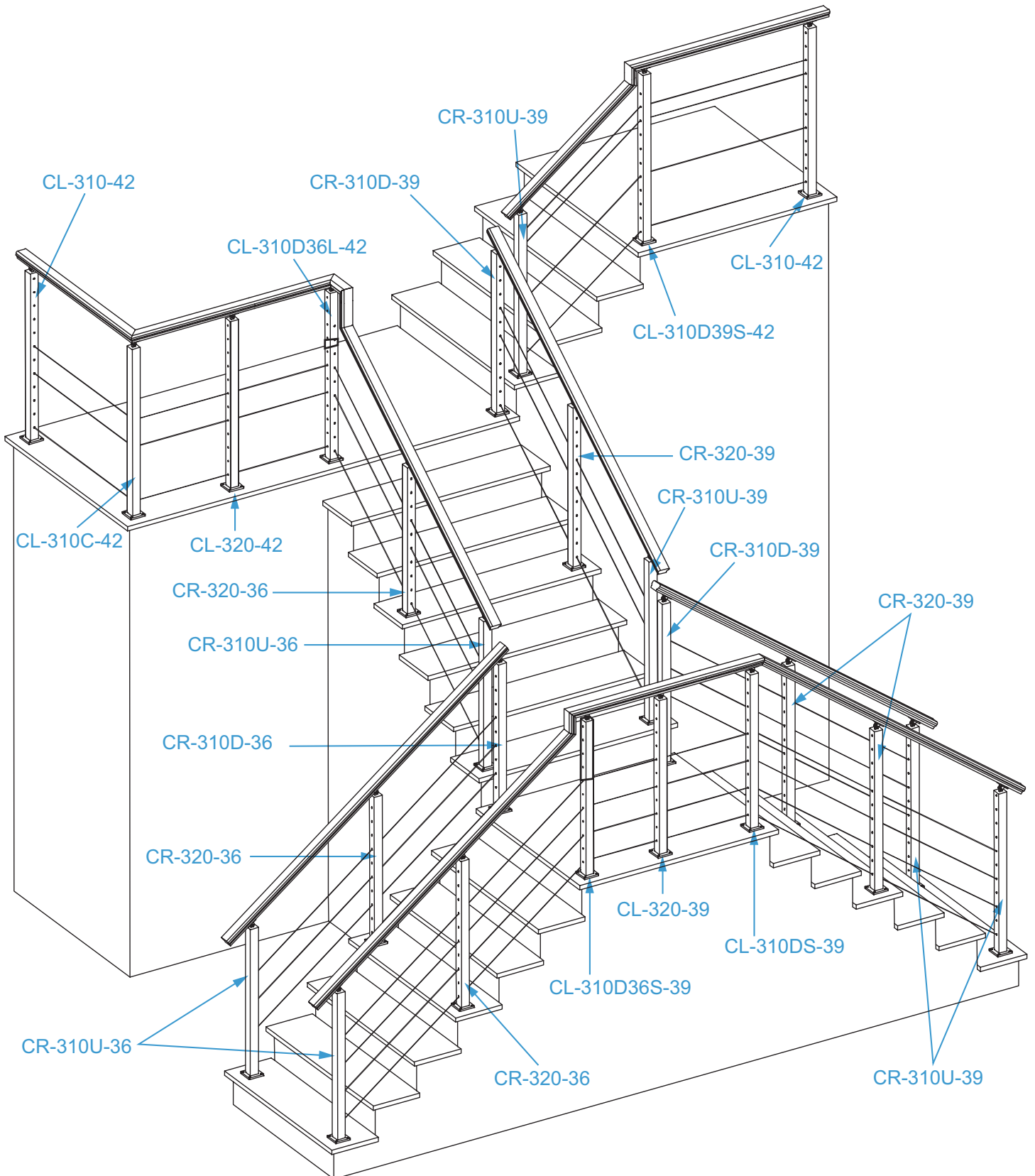

Kneewall Stairway Anatomy

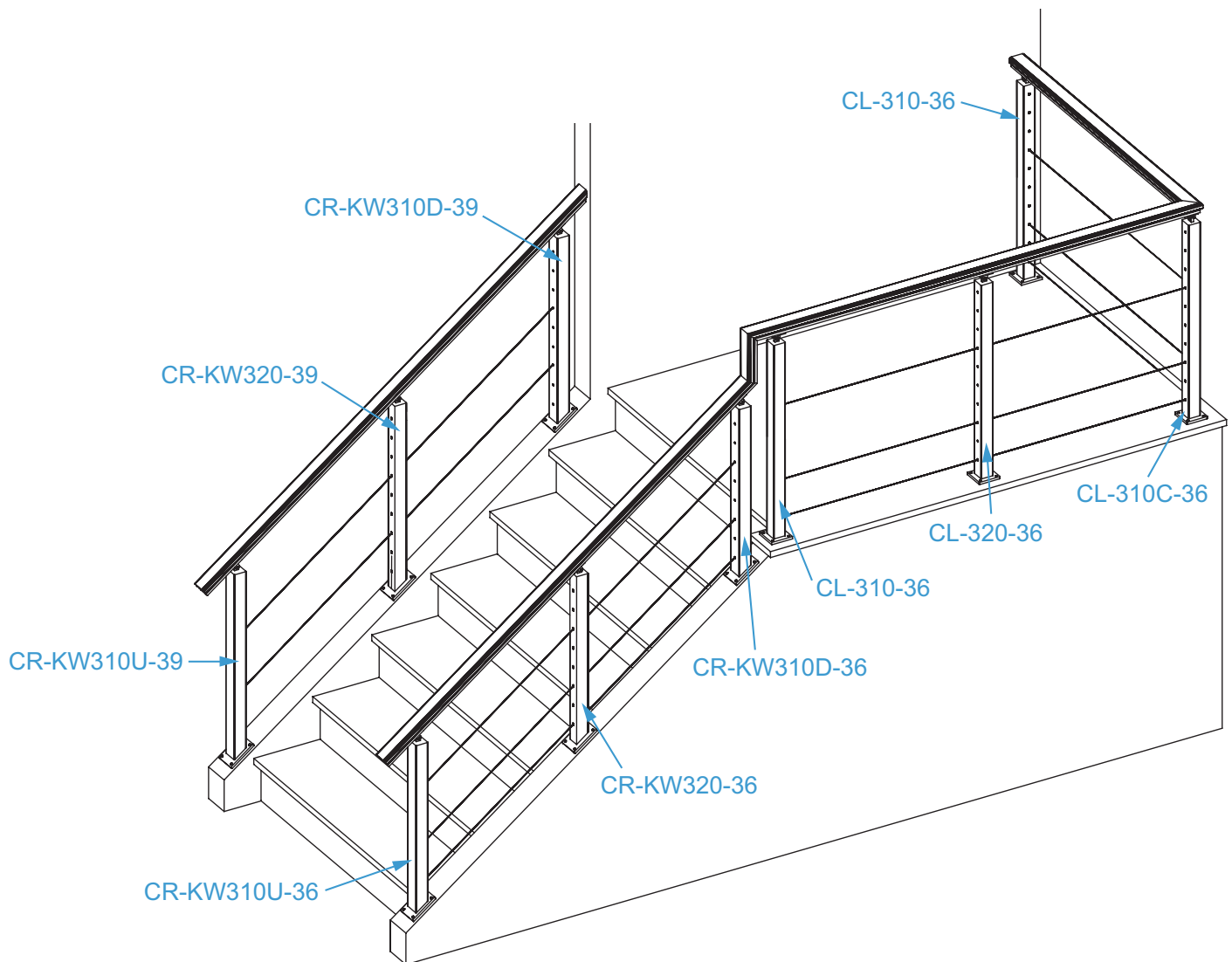

Linear Cable System Features & Benefits

- Marine Grade 316 Stainless Steel Cable and Fittings for lasting beauty and very low maintenance
- Swageless Cable Fittings eliminate the need for expensive equipment
- Unique Linear designed newels sized and drilled for simplified installation
- Modern and code compliant handrail profile for a clean, refined look
- Box or Square Nose Treads create a modern designed stairway

WOOD NEWELS FOR CABLE SYSTEM

Level Run Newels

Rake Newels

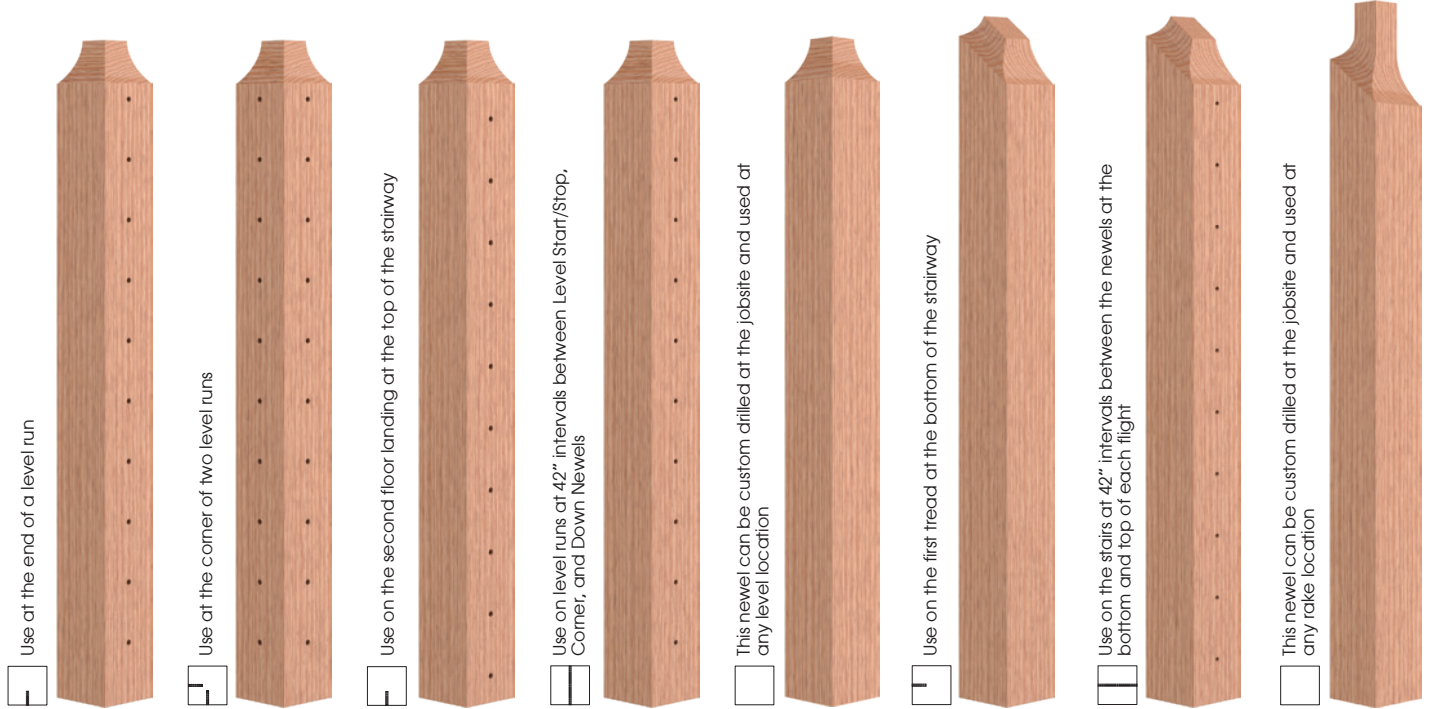

| | Level Start/Stop | Level Corner | Level Down | Level Pass Through | Level Blank | Rake Up | Rake Pass Through | Rake Blank |
|----------|--------------------------------|---------------------------------|----------------------------------|--------------------------------|-------------------------------|---------------------------------|--------------------------------|--------------------------------|
| 10 Holes | CL-410-36 3½" x 34¾" | CL-410C-36 3½" x 34¾" | CL-410D-36 3½" x 34¾" | CL-420-36 3½" x 34¾" | B-400-48 3½" x 47½" | CR-410U-36 3½" x 35¾" | CR-420-36 3½" x 35¾" | BR-400-48 3½" x 47½" |
| 11 Holes | CL-410-39 3½" x 37¾" | CL-410C-39 3½" x 37¾" | CL-410D-39* 3½" x 37¾" | CL-420-39 3½" x 37¾" | | CR-410U-39 3½" x 38¾" | CR-420-39 3½" x 38¾" | |
| 12 Holes | CL-410-42 3½" x 40¾" | CL-410C-42 3½" x 40¾" | CL-410D-42* 3½" x 40¾" | CL-420-42 3½" x 40¾" | | | | |

* Drilled for 10 Cables

Each newel post includes a ¾" x 2" wood dowel (Dowel) for attaching the 684 Handrail

See page 14 for cable, cable fittings and cable accessories. All wood newels are for interior use only.

IMPORTANT: Our Wood Newels above and Cable System is designed for stairways with 7-1/2" rise and 10" run (approx. 36.9°)

Newel Suggestions for Post to Post Systems

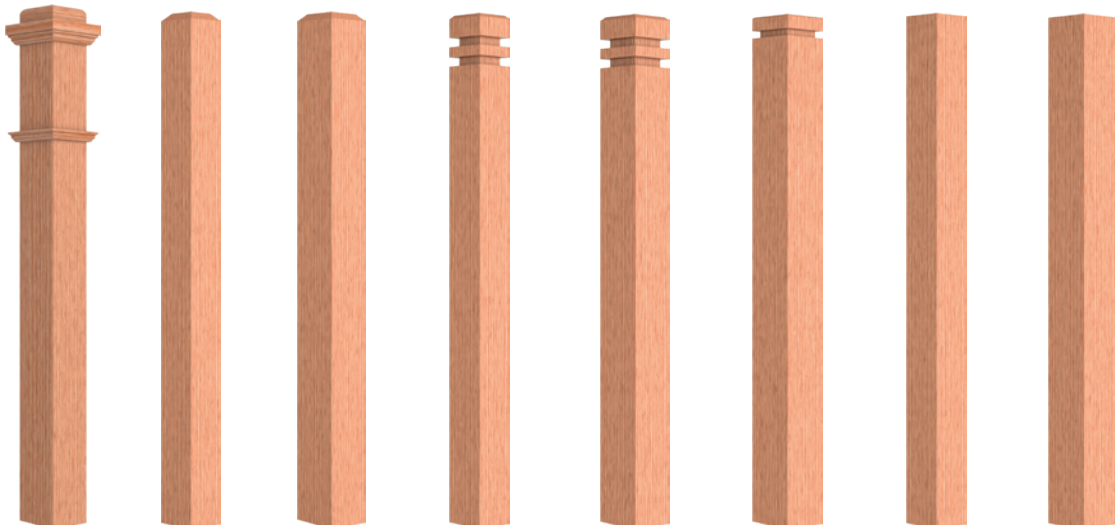

| | | | | | | | |
|-----------------------------|----------------------------|-----------------------------|-------------------------------|--------------------------------|------------------------------|----------------------------------|--------------------------------|
| LJ-4075 3½" x 56" | LJ-4110 3" x 48" | LJ-4000 3½" x 48" | AS300MD-48 3" x 48" | AS350MD-48 3½" x 48" | LJ-4101G 3½" x 58" | LJ-4101-3.0 3" x 58" | LJ-4101 3½" x 58" |
| | LJ-4111 3" x 58" | LJ-4001 3½" x 58" | | | | LJ-4101-3.25 3¼" x 58" | LJ-4101-4.0 4" x 58" |

Newel Mounting Kit for all Wood Newels

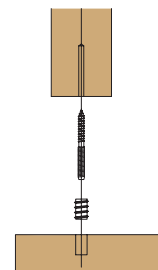

LJ-3004-3.5
Hanger Bolt & Threaded Insert

WOOD NEWELS FOR TUBE SYSTEM

Level Run Newels

Rake Newels

Use at the end of a level run

Use at the corner of two level runs

Use on the second floor landing at the top of the stairway

Use on level runs at 48" intervals between Level Start/Stop, Corner, and Down Newels

This newel can be custom bored at the jobsite and used at any level location

Use on the first tread at the bottom of the stairway

Use on the stairs at 48" intervals between the newels at the bottom and top of each flight

This newel can be custom bored at the jobsite and used at any rake location

| | Level Start/Stop | Level Corner | Level Down | Level Center | Level Blank | Rake Up | Rake Center | Rake Blank |
|---------|--------------------------------|---------------------------------|-----------------------------------|--------------------------------|-------------------------------|---------------------------------|--------------------------------|--------------------------------|
| 7 Holes | TL-410-36 3½" x 34⅜" | TL-410C-36 3½" x 34⅜" | TL-410D-36 3½" x 34⅜" | TL-420-36 3½" x 34⅜" | B-400-48 3½" x 47½" | TR-410U-36 3½" x 35¾" | TR-420-36 3½" x 35¾" | BR-400-48 3½" x 47½" |
| 8 Holes | TL-410-39 3½" x 37⅜" | TL-410C-39 3½" x 37⅜" | TL-410D-39** 3½" x 37⅜" | TL-420-39 3½" x 37⅜" | | TR-410U-39 3½" x 39⅞" | TR-420-39 3½" x 39⅞" | |
| 9 Holes | TL-410-42 3½" x 40⅜" | TL-410C-42 3½" x 40⅜" | TL-410D-42** 3½" x 40⅜" | TL-420-42 3½" x 40⅜" | | | | |

** Drilled for 7 Tubes

Each newel post includes a ¾" x 2" wood dowel (Dowel) for attaching the 684 Handrail

Installation Instructions are available on our website at www.LJSmith.com. This system is for interior use only.

IMPORTANT: Our Wood Newels above and Tube System is designd for stairways with 7-1/2" rise and 10" run (approx. 36.9°)

Tube and Adhesive for Tube System

3/4" Hollow 304 Grade Stainless Steel Tube



TUBE-005-SS - 5' Length
TUBE-020-SS - 20' Length

Compatible with the predrilled newels on this page



LI-3703
Contractor Epoxy Adhesive Mixing Nozzle



LI-3702
Contractor Injector Tool



LI-3701
Contractor Epoxy Adhesive

(Open work time is 18 minutes. Fills approximately 122 holes depending on hole size. Includes mixing nozzle. 28 Oz Gray. Dries Gray)



6100E-10AD
Non-Sag Adhesive

(Use with a standard caulk gun cartridge. Fills approximately 110 holes depending on hole size. 10.2 Oz Clear Adhesive. Dries clear)



EGEXTREME-10AD
Extreme Environmentally Friendly Adhesive

(Use with a standard caulk gun cartridge. Fills approximately 110 holes depending on hole size. 10.1 Oz White Adhesive. Dries white)



5/8" Hollow Steel Tube
Low Sheen Black Finish

TUBE-58-008-LSB - 8' Length

Not compatible with the predrilled newels on this page. Use with Blank Newels B-400-48, BR-400-48 or any of the Post to Post Newels on the bottom of the prior page.

WOOD NEWELS & CABLE SYSTEM

Stairway Anatomy

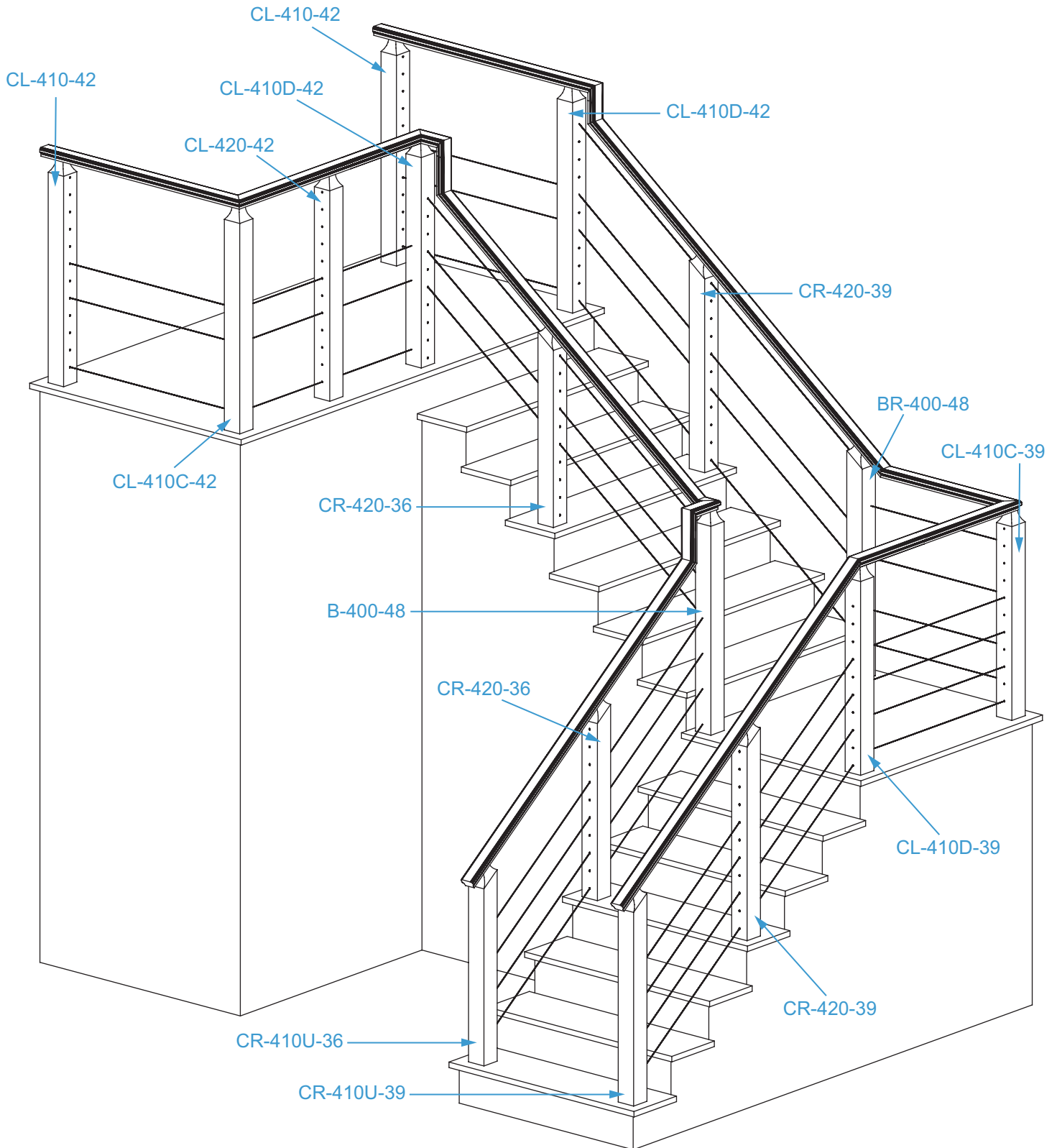

WOOD NEWELS & TUBE SYSTEM

Stairway Anatomy

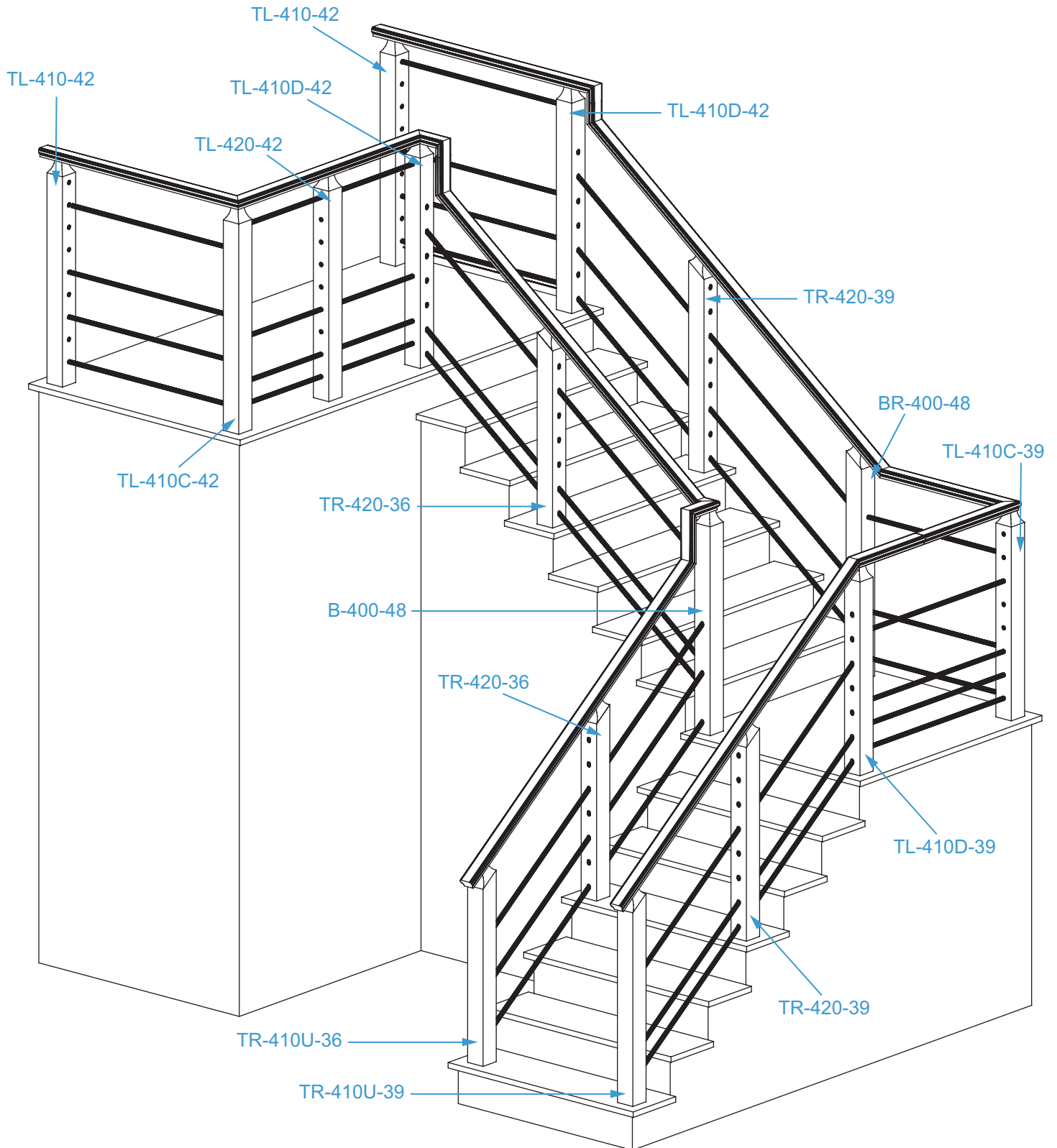

CABLE, HANDRAIL, TREADS

Cable Fittings for Metal Newels

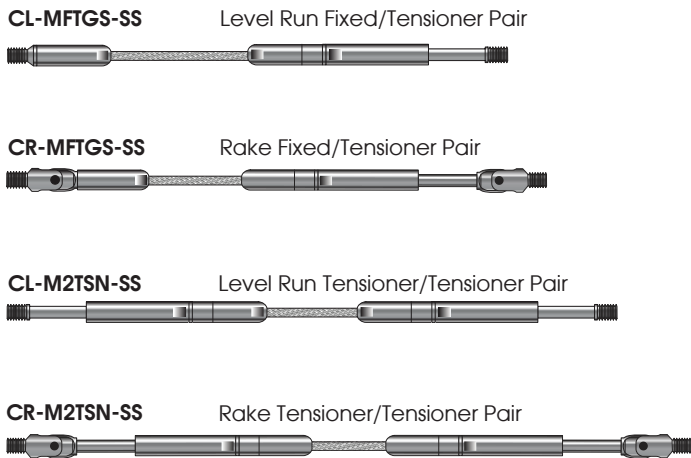

Cable Fittings for Wood Newels

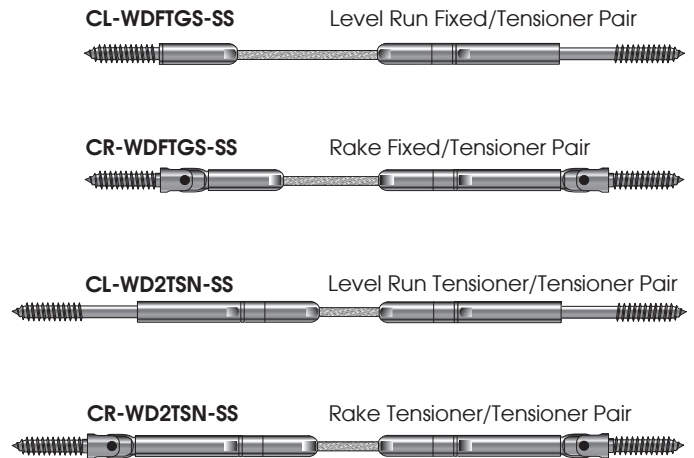

1/8" Marine Grade 316
Stainless Steel Cable
(1x19 construction)

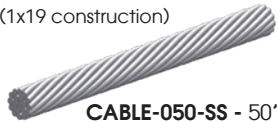

CABLE-050-SS - 50' Roll
CABLE-150-SS - 150' Roll
CABLE-500-SS - 500' Roll

Cable Release
Tool

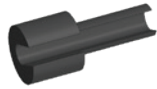

C-RELEASE

Cable Cutter



C-CUTTER

Stainless Steel
Cleaner &
Protectant



C-CLEANER

Post Protector Tube
(For wood newels only)

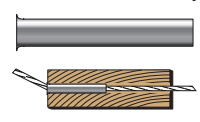

C-PROTECTOR

Handrail and Handrail Fittings



684
Handrail
2 5/8" x 1 5/8"



784QTR
Quarterturn



784UE
Upsealing



784OE
Oversealing



784LHGN
Left Hand
Gooseneck



784RHGN
Right Hand
Gooseneck



784SGN
Straight
Gooseneck

Treads, Risers, Landing Tread, False Treads



LJ-8870
Square Nose Plain Tread
1" x 11-1/2"
Lengths: 42", 48", 54"



LJ-88701RV
Square Nose Tread with
Miter Return on 1 End
(Reversible)
1" x 11-1/2"
Lengths: 42", 48", 54"



LJ-8870MR2
Square Nose Tread with
Miter Return on Both
Ends
1" x 11-1/2"
QUOTED ITEM



LJ-8075
Riser
3/4" x 7 1/2" or 8"
Lengths: 42", 48", 54"

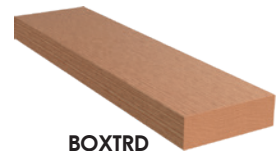

BOXTRD
Face Laminated Solid Tread
3-1/2" x 11-1/2"
Lengths: 42", 48"



LJ-8879
Square Nose False Tread Kit
7-5/16" x 12-5/8"
For open tread left hand,
open tread right hand or
closed tread applications.



LJ-8890-5
Square Nose Landing Tread
5-1/4" x random length



LJ-8895
Cove/Shoe/Trim Moulding
3/4" x 3/4" x random length

ORDERING GUIDELINES—

METAL PANEL SYSTEM



The following guidelines are designed to provide an accurate and complete list of components necessary to complete your panel railing system. This checklist and our Linear Collection Metal Panel Systems brochure will provide the flexibility to comply with most building codes as they relate to handrail height and infill spacing requirements. **The following guidelines are designed for stairways with 7 1/2" rise and 10" run (approx 36.9°)**, a rake handrail height of 36" and level handrail heights between 36" and 43" (depending on handrail used, curb wall height, amount panels are elevated, etc.). All metal panel lengths are plan view measurements. This system is for interior use only. **Consult your local building code official before purchasing and installing this system.**

| Item | Guidelines | Part # | Qty. |
|---|--|--------|------|
| 1 TREADS | Select one tread for each step. If false treads are utilized, select one or two kits per tread depending on application. | | |
| 2 RISERS | Select one riser for each step and select one more riser per each flight. | | |
| 3 LANDING TREAD | Select sufficient lineal footage of LJ-8890-5 for the entire balcony and width of stairs at each landing. Custom landing tread can also be quoted and ordered. | | |
| 4 COVE MOULD | Applicable for level runs and stairs with risers. Select sufficient lineal footage of LJ-8895 cove moulding to go under all tread nosing (including miter returns) and under all landing tread. Cove moulding is not needed under false treads. | | |
| 5 RAKE PANELS | Open Tread Stairways: Select the appropriate sizes and quantity of open tread stair panels to fill the plan view layout of the open tread stairway rake. Spaces between panels can be no more than 4". Be sure to take into consideration the 1/2" thickness of each Panel Post and 1" thickness of each Spacer Newel (see 7 & 8 below) when calculating the spacing. Select from the following rake panels: (sizes indicated are plan view widths) PR-O1236 (12"), PR-O1836 (18"), PR-O2436 (24"), PR-O3036 (30"), PR-O3636 (36") Kneewall Stairways: Select the appropriate sizes and quantity of kneewall stair panels to fill the plan view layout of the kneewall stairway rake. Spaces between panels can be no more than 4". Be sure to take into consideration the 1" thickness of each Spacer Newel if used (see 8 below) when calculating the spacing. Select from the following rake panels: (sizes indicated are plan view widths) PR-K1236 (12"), PR-K1836 (18"), PR-K2436 (24"), PR-K3036 (30"), PR-K3636 (36") | | |
| 6 LEVEL RUN PANELS | Elevated Panels: Select the appropriate sizes and quantity of panels to fill the plan view layout of each level run. Spaces between panels can be no more than 4". Be sure to take into consideration the 1/2" thickness of each Panel Post and 1" thickness of each Spacer Newel (see 7 & 8 below) when calculating the spacing. Select from the following level panels for a 39" level rail height: PL-CE1239 (12"), PL-CE1839 (18"), PL-CE2439 (24"), PL-CE3039 (30"), PL-CE3639 (36"), PL-CE4239 (42"), PL-CE4839 (48"). Select from the following level panels for a 43" level rail height: PL-CE1243 (12"), PL-CE1843 (18"), PL-CE2443 (24"), PL-CE3043 (30"), PL-CE3643 (36"), PL-CE4243 (42"), PL-CE4843 (48") Curb Wall Panels: Select the appropriate sizes and quantity of panels to fill the plan view layout of each level run. Spaces between panels can be no more than 4". Be sure to take into consideration the 1" thickness of each Spacer Newel if used (see 8 below) when calculating the spacing. Select from the following level panels for a 39" level rail height: PL-CE1239 (12"), PL-CE1839 (18"), PL-CE2439 (24"), PL-CE3039 (30"), PL-CE3639 (36"), PL-CE4239 (42"), PL-CE4839 (48"). Select from the following level panels for a 43" level rail height: PL-CE1243 (12"), PL-CE1843 (18"), PL-CE2443 (24"), PL-CE3043 (30"), PL-CE3643 (36"), PL-CE4243 (42"), PL-CE4843 (48") Flush Mount Panels: Select the appropriate sizes and quantity of panels to fill the plan view layout of each level run. Spaces between panels can be no more than 4". Be sure to take into consideration the 1" thickness of each Spacer Newel if used (see 8 below) when calculating the spacing. Select from the following level panels for a 36" level rail height: PL-F1236 (12"), PL-F1836 (18"), PL-F2436 (24"), PL-F3036 (30"), PL-F3636 (36"), PL-F4236 (42"), PL-F4836 (48"). Select from the following level panels for a 39" level rail height: PL-F1239 (12"), PL-F1839 (18"), PL-F2439 (24"), PL-F3039 (30"), PL-F3639 (36"), PL-F4239 (42"), PL-F4839 (48"). | | |
| 7 PANEL POSTS | Panel Posts are used on open tread stairways and elevated panel level runs. Select 2 Panel Posts with 2-Hole Foot Plate (P-POST2H) per panel. The Panel Post with 4-Hole Foot Plate (P-POST4H) is often used at the end of a level run that end near a wall. NOTE: A Panel Post kit (P-POSTKIT2H) is available that includes: 2 Panel Posts with 2-Hole Foot Plate (P-POST2H), 4 Post Foot Lag Screws (P-POSTFTSCR2.75) and 6 Post and Barrel Bolts (P-POSTBOLT1.0). | | |
| 8 SPACER NEWELS | Spacer newels must be used in any space between panels that is over 4" to comply with building codes. Also, rake and level runs cannot exceed 15' without a spacer newel. Kneewall Stairways: Select the necessary quantity of Kneewall Spacer Newels (PR-K36NWL2H). Level Run Elevated Panels: Select the necessary quantity of Level Spacer Newels. For a 39" level rail height: PL-E39NWL4H. For a 43" level rail height: PL-E43NWL4H Level Run Curb Wall Panels: Select the necessary quantity of Level Spacer Newels. For a 39" level rail height: PL-C39NWL4H. For a 43" level rail height: PL-C43NWL4H Level Run Flush Mount Panels: Select the necessary quantity of Level Spacer Newels. For a 36" level rail height: PL-F36NWL4H. For a 39" level rail height: PL-F39NWL4H | | |
| 9 HARDWARE | Every rake and level panel comes with screws for attachment to the handrail. Screws are also included for the bottom of each panel (use for level flush mount, level curb wall mount and kneewall stair applications only). Spacer newels and panel posts include post foot lag screws. Spacer newels also include screws for attachment to the handrail. Each panel post includes 3 panel post and barrel fasteners. The panel post kit includes 6 panel post and barrel fasteners and 4 post foot lag screws. Each of these hardware items are also available separately, if needed. See pages 2 & 4. | | |
| 10 HANDRAIL | Select 684 handrail at a rate of 13" per each tread and include enough for all level runs and walls (if wall rail is required). Handrail is available in 8', 10', 12', 14', & 16' lengths. | | |
| 11 HANDRAIL GOOSENECK FITTINGS | A gooseneck handrail fitting must be used for the following rake to level run transitions: 36" rake to 39" level; 36" rake to 42" level; 39" rake to 42" level. Select the appropriate gooseneck fitting: 784LHGN (Left Hand Gooseneck), 784RHGN (Right Hand Gooseneck), 784SGN (Straight Gooseneck) | | |
| 12 HANDRAIL FITTINGS (Miscellaneous Components) | Select the necessary Overeasing, Upeasing and Level Quarterturns as needed for changes in elevation and/or direction of the handrail. If continuous handrail is needed to transition from the rake, around a wall, and continue up the stair as wall rail, select two Level Quarterturns. Select from these fittings: 784OE (Overeasing), 784UE (Upeasing), 784QTR (Level Quarterturn) | | |

ORDERING GUIDELINES—

METAL NEWELS &
CABLE SYSTEM



The following guidelines are designed to provide an accurate and complete list of components necessary to complete your metal newel post and cable railing system. This checklist and our Linear Collection brochure will provide the flexibility to comply with most building codes as they relate to handrail height and infill spacing requirements. **The following guidelines are designed for stairways with 7 1/2" rise and 10" run (approx 36.9°)**, a rake handrail height of 34"-38" and a level handrail height of 36", 39" or 42". These guidelines also follow our recommendation of installing a newel at every corner or change in direction making each straight run having separate cable with a fixed cable fitting on one end and a tensioner cable fitting on the other end into the newel posts. Tensioner cable fittings should be used on both ends of **any** cable run that is 25' to 50' long. Wood components are for interior use only. Cable, cable fittings and metal newels are for interior or exterior use. **Consult your local building code official before purchasing and installing this system.**

| Item | Guidelines | Part # | Qty. |
|--|--|--------|------|
| 1 TREADS | Select one tread for each step. If false treads are utilized, select one or two kits per tread depending on application. (Interior stairs only) | | |
| 2 RISERS | Select one riser for each step and select one more riser per each flight. (Interior stairs only) | | |
| 3 LANDING TREAD | Select sufficient lineal footage of LJ-8890-5 landing tread for the entire balcony and width of stairs at each landing. Custom landing tread can also be quoted and ordered. (Interior stairs only) | | |
| 4 COVE MOULD | Applicable for level runs and stairs with risers. Select sufficient lineal footage of LJ-8895 cove moulding to go under all tread nosing (including miter returns) and under all landing tread. Cove moulding is not needed under false treads. (Interior stairs only) | | |
| 5 RAKE UP NEWEL | Open Tread Stairways: For stairs with a 34"-36" rake rail height, select the CR-310U-36 at the bottom of the stair flight. For 36"-38" rake rail height, select the CR-310U-39. If the stairway is open on both sides, two of these newels will be needed. See the Linear Metal Newel Applications chart at the bottom of this page for further information. Kneewall Stairways: For stairs with a 34"-36" rake rail height, select the CR-KW310U-36 at the bottom of the stair flight. For 36"-38" rake rail height, select the CR-KW310U-39. If the stairway is open on both sides, two of these newels will be needed. See the Linear Metal Newel Applications chart at the bottom of this page for further information. | | |
| 6 RAKE PASS THROUGH NEWEL | Open Tread Stairways: The distance between the rake newels should not exceed 42". Use in the middle of a rake run of handrail to keep the spacing between the newel posts at 42" or less. For stairs with a 34"-36" rake rail height, select the CR-320-36. For 36"-38" rake rail height, select the CR-320-39. Kneewall Stairways: The distance between the rake newels should not exceed 42". Use in the middle of a rake run of handrail to keep the spacing between the newel posts at 42" or less. For stairs with a 34"-36" rake rail height, select the CR-KW320-36. For 36"-38" rake rail height, select the CR-KW320-39. | | |
| 7 RAKE DOWN NEWEL | Open Tread Stairways: Use this newel at the top of any open tread stair flight that ends at a wall. For stairs with a 34"-36" rake rail height, select the CR-310D-36. For stairs with a 36"-38" rake rail height, select the CR-310D-39. Kneewall Stairways: Use this newel at the top of any kneewall stair flight. For stairs with a 34"-36" rake rail height, select the CR-KW310D-36. For stairs with a 36"-38" rake rail height, select the CR-KW310D-39. | | |
| 8 LEVEL DOWN NEWEL | Open Tread Stairways Only: There are three different types of Level Down Newels for use at the top of open tread stairways at the second floor landing. Based on the application details below, please select the appropriate second floor landing newel(s). Transition from stair rake and continues straight to a level run: For 34"-36" rake rail height transitioning to 36" level rail height select the CL-310DS-36. For 34"-36" rake rail height transitioning to 39" level rail height select the CL-310D36S-39. For 34"-36" rake rail height transitioning to 42" level rail height select the CL-310D36S-42. For 36"-38" rake rail height transitioning to 39" level rail height select the CL-310DS-39. For 36"-38" rake rail height transitioning to 42" level rail height select the CL-310D39S-42. Transition from stair rake and turns left to a level run: For 34"-36" rake rail height transitioning to 36" level rail height select the CL-310DL-36. For 34"-36" rake rail height transitioning to 39" level rail height select the CL-310D36L-39. For 34"-36" rake rail height transitioning to 42" level rail height select the CL-310D36L-42. For 36"-38" rake rail height transitioning to 39" level rail height select the CL-310DL-39. For 36"-38" rake rail height transitioning to 42" level rail height select the CL-310D39L-42. Transition from stair rake and turns right to a level run: For 34"-36" rake rail height transitioning to 36" level rail height select the CL-310DR-36. For 34"-36" rake rail height transitioning to 39" level rail height select the CL-310D36R-39. For 34"-36" rake rail height transitioning to 42" level rail height select the CL-310D36R-42. For 36"-38" rake rail height transitioning to 39" level rail height select the CL-310DR-39. For 36"-38" rake rail height transitioning to 42" level rail height select the CL-310D39R-42. | | |
| 9 LEVEL CORNER NEWEL | For 36" level rail height, select the CL-310C-36 for the newel at the corner of two level runs. For 39" level rail height, select the CL-310C-39. For 42" level rail height, select the CL-310C-42. | | |
| 10 LEVEL START/STOP NEWEL | Cable fittings may be installed directly into the wall at the end of a level run, or they can be installed into a newel post at the end of the run that is placed next to the wall. If ending a level run with a newel post, select the CL-310-36 for 36" level rail height. Select the CL-310-39 for 39" level rail height. Select the CL-310-42 for 42" level rail height. These newels are also used to start the level run that transitions from the top of a kneewall stair flight. | | |
| 11 LEVEL PASS THROUGH NEWEL | The distance between the level run newels should not exceed 42". Use the Level Pass Through Newel at 42" intervals in the middle of a level run. For 36" level rail height, select the CL-320-36. For 39" level rail height, select the CL-320-39. For 42" level rail height, select the CL-320-42. | | |
| 12 RAKE FIXED/TENSIONER CABLE FITTINGS PAIR (CR-MFTGS-SS) | Each rake cable run requires a CR-MFTGS-SS (Rake Fixed/Tensioner Pair). Calculate the total number of rake cable fitting pairs needed based on the Rake Up Newel(s) selected in #4 above. Be sure to include enough cable fitting pairs for each flight. Do not include Rake Pass Through Newels (CR-320) when calculating cable fitting sets required since the cable will simply "pass through" this newel. Open Tread Stairways: CR-310U-36 requires 10 pairs; CR-310U-39 requires 11 pairs Kneewall Stairways: CR-KW310U-36 requires 8 pairs; CR-KW310U-39 requires 9 pairs For any cable run of 25' to 50' long, tensioner cable fittings should be used on both ends of the cable to achieve the desired tensioning on both directions of cable. Item CR-M2TSN-SS contains 2 Rake Tensioners. | | |
| 13 LEVEL RUN FIXED/TENSIONER CABLE FITTINGS PAIR (CL-MFTGS-SS) | Each level cable run requires a CL-MFTGS-SS (Level Fixed/Tensioner Pair). Calculate the level cable fitting pairs needed by taking the number of straight level runs times the number of pairs required for the selected newels. CL-310-36 requires 10 pairs; CL-310-39 requires 11 pairs; CL-410-42 requires 12 pairs. Do not include Level Pass Through Newels (CL-320) when calculating cable fitting sets required since the cable will simply "pass through" this newel. For any cable run of 25' to 50' long, tensioner cable fittings should be used on both ends of the cable to achieve the desired tensioning on both directions of cable. Item CL-M2TSN-SS contains 2 Level Run Tensioners. | | |
| 14 1/8" CABLE | Calculate enough cable to run between every Fixed/Tensioner Cable Fitting Pair as well as between every Tensioner/Tensioner Cable Fitting Pair. Cable runs should be no longer than 50'. Cable is available in 50' (CABLE-050-SS), 150' (CABLE-150-SS) and 500' (CABLE-500-SS) spools. | | |
| 15 HANDRAIL | Select 684 handrail at a rate of 13" per each tread and include enough for all level runs and walls (if wall rail is required). Handrail is available in 8', 10', 12', 14', & 16' lengths. (Interior stairs only, however exterior 684 can be quoted) | | |
| 16 HANDRAIL GOOSENECK FITTINGS | A gooseneck handrail fitting must be used for the following rake to level run transitions: 36" rake to 39" level; 36" rake to 42" level; 39" rake to 42" level. Select the appropriate gooseneck fitting: 784LHGN (Left Hand Gooseneck), 784RHGN (Right Hand Gooseneck), 784SGN (Straight Gooseneck) (Interior stairs only, however exterior gooseneck fittings can be quoted) | | |
| 17 HANDRAIL FITTINGS (Miscellaneous Components) | Select the necessary Overeasing, Upeasing and Level Quarterturns as needed for changes in elevation and/or direction of the handrail. If continuous handrail is needed to transition from the rake, around a wall, and continue up the stair as wall rail, select two Level Quarterturns. Select from these fittings: 784OE (Overeasing), 784UE (Upeasing), 784QTR (Level Quarterturn) (Interior stairs only, however exterior handrail fittings can be quoted) | | |
| 18 ACCESSORIES | Select a Cable Release Tool (C-RELEASE), Cable Cutters (C-CUTTER), Stainless Steel Cleaner & Protectant (C-CLEANER). | | |

Linear Metal Newel Applications

| | |
|---|--|
| Open Tread Rake Up Newel (CR-310U) | Use this newel as the starting newel on the first tread at the bottom of an open tread stairway flight. |
| Open Tread Rake Pass Through Newel (CR-320) | Use this newel on open tread stairs at 42" intervals between the newels at the bottom and top of each flight. |
| Open Tread Rake Down Newel (CR-310D) | Use this newel at the top of the first flight of any L-shaped open tread stairway. Also used at the top of any flight that ends at a wall. |
| Kneewall Rake Up Newel (CR-KW310U) | Use this newel as the starting newel on the first tread at the bottom of a kneewall stairway flight. |
| Kneewall Rake Pass Through Newel (CR-KW320) | Use this newel on kneewall stairs at 42" intervals between the newels at the bottom and top of each flight. |
| Kneewall Rake Down Newel (CR-KW310D) | Use this newel at the top of any kneewall stairway flight. |
| Level Start/Stop Newel (CL-310) | Use this newel at the beginning or end of each level run. Also used on the level run that transitions from a kneewall stair flight. |
| Level Pass Through Newel (CL-320) | Use this newel on level runs midway between the Level Start/Stop, Level Corner and Level Down Newels at 42" intervals. |
| Level Corner Newel (CL-310C) | Use this newel at the corner of two level runs. |
| Level Down to Level Straight Newel (CL-310DS) | Use this newel on the second floor landing at the top of the stairway flight that transitions to a straight level run. |
| Level Down to Level Left Newel (CL-310DL) | Use this newel on the second floor landing at the top of the stairway flight that transitions left to a level run. |
| Level Down to Level Right Newel (CL-310DR) | Use this newel on the second floor landing at the top of the stairway flight that transitions right to a level run. |

The following guidelines are designed to provide an accurate and complete list of components necessary to complete your wood newel post and cable or tube railing system. This checklist and our Linear Collection brochure will provide the flexibility to comply with most building codes as they relate to handrail height and infill spacing requirements. **The following guidelines are designed for stairways with 7 1/2" rise and 10" run (approx 36.9°), a rake handrail height of 34"-38" and a level handrail height of 36", 39" or 42".** These guidelines also follow our recommendation of installing a newel at every corner or change in direction making each straight run separate cable with a fixed cable fitting on one end and a tensioner cable fitting on the other end into the newel posts. However, you can run cable through two Pass Through Newels (positioned at 45° from one another) with Post Protector Tubes to turn a corner, but tensioner cable fittings must be used on both ends of the cable to achieve the desired tensioning on both directions of cable. Tensioner cable fittings should also be used on both ends of any cable run that is 25' to 50' long. These systems are for interior use only. **Consult your local building code official before purchasing and installing this system.**

| Item | Guidelines | Part # | Qty. |
|------|---|--------|------|
| 1 | TREADS Select one tread for each step. If false treads are utilized, select one or two kits per tread depending on application. | | |
| 2 | RISERS Select one riser for each step and select one more riser per each flight. | | |
| 3 | LANDING TREAD Select sufficient lineal footage of LJ-8890-5 for the entire balcony and width of stairs at each landing. Custom landing tread can also be quoted and ordered. | | |
| 4 | COVE MOULD Applicable for level runs and stairs with risers. Select sufficient lineal footage of LJ-8895 cove moulding to go under all tread nosing (including miter returns) and under all landing tread. Cove moulding is not needed under false treads. | | |
| 5 | RAKE UP NEWEL CABLE SYSTEM: For stairs with a 34"-36" rake rail height, select the CR-410U-36 at the bottom of the stairway at the first floor. For 36"-38" rake rail height, select the CR-410U-39. If the stairway is open on both sides, two of these newels will be needed. See the Wood Linear Newel Applications chart at the bottom of this page for further information. TUBE SYSTEM: For stairs with a 34"-36" rake rail height, select the TR-410U-36 at the bottom of the stairway at the first floor. For 36"-38" rake rail height, select the TR-410U-39. If the stairway is open on both sides, two of these newels will be needed. See the Wood Linear Newel Applications chart at the bottom of this page for further information. | | |
| 6 | RAKE PASS THROUGH NEWEL (Cable) CABLE SYSTEM: The distance between the rake newels should not exceed 42". Use in the middle of a rake run of handrail to keep the spacing between the newel posts at 42" or less. For stairs with a 34"-36" rake rail height, select the CR-420-36. For 36"-38" rake rail height, select the CR-420-39. RAKE CENTER NEWEL (Tube) TUBE SYSTEM: The distance between the rake newels should not exceed 48". Use in the middle of a rake run of handrail to keep the spacing between the newel posts at 48" or less. For stairs with a 34"-36" rake rail height, select the TR-420-36. For 36"-38" rake rail height, select the TR-420-39. | | |
| 7 | LEVEL DOWN NEWEL CABLE SYSTEM: For 36" level rail height, select the CL-410D-36 for the newel on the second floor landing at the top of the stairway flight. For 39" level rail height, select the CL-410D-39. For 42" level rail height, select the CL-410D-42. TUBE SYSTEM: For 36" level rail height, select the TL-410D-36 for the newel on the second floor landing at the top of the stairway flight. For 39" level rail height, select the TL-410D-39. For 42" level rail height, select the TL-410D-42. | | |
| 8 | LEVEL CORNER NEWEL CABLE SYSTEM: For 36" level rail height, select the CL-410C-36 for the newel at the corner of two level runs. For 39" level rail height, select the CL-410C-39. For 42" level rail height, select the CL-410C-42. TUBE SYSTEM: For 36" level rail height, select the TL-410C-36 for the newel at the corner of two level runs. For 39" level rail height, select the TL-410C-39. For 42" level rail height, select the TL-410C-42. | | |
| 9 | LEVEL START/STOP NEWEL CABLE SYSTEM: Cable fittings may be installed directly into the wall at the end of a level run, or they can be installed into a newel post at the end of the run that is placed next to the wall. If ending a level run with a newel post, select the CL-410-36 for 36" level rail height. Select the CL-410-39 for 39" level rail height. Select the CL-410-42 for 42" level rail height. TUBE SYSTEM: Tube should be installed into a newel post at the end of the level run that is placed next to the wall. Select the TL-410-36 for 36" level rail height. Select the TL-410-39 for 39" level rail height. Select the TL-410-42 for 42" level rail height. | | |
| 10 | LEVEL PASS THROUGH NEWEL (Cable) CABLE SYSTEM: The distance between the level run newels should not exceed 42". Use the Level Pass Through Newel at 42" intervals in the middle of a level run. For 36" level rail height, select the CL-420-36. For 39" level rail height, select the CL-420-39. For 42" level rail height, select the CL-420-42. LEVEL CENTER NEWEL (Tube) TUBE SYSTEM: The distance between the level run newels should not exceed 48". Use the Center Newel at 48" intervals in the middle of a long level run. For 36" level rail height, select the TL-420-36. For 39" level rail height, select the TL-420-39. For 42" level rail height, select the TL-420-42. | | |
| 11 | BLANK NEWEL Blank newels are used when the location of the drilled holes needs to be different from the predrilled holes in our standard Linear Collection newels. Use the B-400-48 at the corner of an intermediate landing and at any level position. Use the BR-400-48 at any rake location. | | |
| 12 | NEWEL MOUNTING KIT Select one LJ-3004-3.5 newel mounting kit for each newel post. | | |
| 13 | RAKE FIXED/TENSIONER CABLE FITTINGS PAIR (CR-WDFTGS-SS) CABLE SYSTEM: To ensure performance of our system, a stabilizing member such as our 3/4" tube or 1 1/4" S4S wood is required between all newel posts at the top pre-drilled position. Each rake cable run requires a CR-WDFTGS-SS (Rake Fixed/Tensioner Pair). Calculate the total number of rake cable fitting pairs needed based on the cable system Rake Up Newel(s) selected in #5 above. CR-410U-36 requires 9 pairs when installing a stabilizing member at the top position (10 pairs without stabilizing member); CR-410U-39 requires 10 pairs when installing a stabilizing member at the top position (11 pairs without stabilizing member). Be sure to include enough cable fitting pairs for each flight. Do not include Rake Pass Through Newels (CR-420) when calculating cable fitting sets required since the cable will simply "pass through" this newel. Any cable run of 25' to 50', or if the cable runs through Pass Through Newels to make a change in direction or elevation, tensioner cable fittings should be used on both ends of the cable to achieve the desired tensioning on both directions of cable. Item CR-WD2TSN-SS contains 2 Rake Tensioners. | | |
| 14 | LEVEL RUN FIXED/TENSIONER CABLE FITTINGS PAIR (CL-WDFTGS-SS) CABLE SYSTEM: To ensure performance of our system, a stabilizing member such as our 3/4" tube or 1 1/4" S4S wood is required between all newel posts at the top pre-drilled position. Each level cable run requires a CL-WDFTGS-SS (Level Fixed/Tensioner Pair). Calculate the level cable fitting pairs needed by taking the number of straight level runs times the number of pairs required for the selected cable system level newels. CL-410-36 requires 9 pairs when installing a stabilizing member at the top position (10 pairs without stabilizing member); CL-410-39 requires 10 pairs when installing a stabilizing member at the top position (11 pairs without stabilizing member); CL-410-42 requires 11 pairs when installing a stabilizing member at the top position (12 pairs without stabilizing member). Do not include Level Pass Through Newels (CL-420) when calculating cable fitting sets required since the cable will simply "pass through" this newel. Any cable run of 25' to 50', or if the cable runs through Pass Through Newels to make a change in direction or elevation, tensioner cable fittings should be used on both ends of the cable to achieve the desired tensioning on both directions of cable. Item CL-WD2TSN-SS contains 2 Level Run Tensioners. | | |
| 15 | POST PROTECTOR TUBE CABLE SYSTEM: Select a C-PROTECTOR (Post Protector Tube) for every instance where the cable enters or exits a Level Pass Through Newel at an angle. Post Protector Tubes keep the cable from biting into the wood. | | |
| 16 | 1/8" CABLE CABLE SYSTEM: Calculate enough cable to run between every Fixed/Tensioner Cable Fitting Pair as well as between every Tensioner/Tensioner Cable Fitting Pair. Cable runs should be no longer than 50'. Cable is available in 50' (CABLE-050-SS), 150' (CABLE-150-SS) and 500' (CABLE-500-SS) spools. | | |
| 17 | 3/4" TUBE CABLE SYSTEM: If using 3/4" Tube as a stabilizing member between newels in a cable system, select enough tube to run between each newel. TUBE SYSTEM: Select enough tube to run between every tube system newel selected. TR/TL-410/420-36 requires 7 tubes; TR/TL-410/420-39 requires 8 tubes; TL-410/420-42 requires 9 tubes. Tube is available in 5' (TUBE-005-SS) or 20' (TUBE-020-SS) lengths. | | |
| 18 | HANDRAIL Select 684 handrail at a rate of 13" per each tread and include enough for all level runs and walls (if wall rail is required). Handrail is available in 8', 10', 12', 14', & 16' lengths. | | |
| 19 | HANDRAIL GOOSENECK FITTINGS A gooseneck handrail fitting must be used for the following rake to level run transitions: 36" rake to 39" level; 36" rake to 42" level; 39" rake to 42" level. Select the appropriate gooseneck fitting: 784LHGN (Left Hand Gooseneck), 784RHGN (Right Hand Gooseneck), 784SGN (Straight Gooseneck) | | |
| 20 | HANDRAIL FITTINGS (Miscellaneous Components) Select the necessary Overeasing, Upeasing and Level Quarterturns as needed for changes in elevation and/or direction of the handrail. If continuous handrail is needed to transition from the rake, around a wall, and continue up the stair as wall rail, select two Level Quarterturns. Select from these fittings: 784OE (Overeasing), 784UE (Upeasing), 784QTR (Level Quarterturn) | | |
| 21 | ACCESSORIES CABLE SYSTEM: Select a Cable Release Tool (C-RELEASE), Cable Cutters (C-CUTTER), Stainless Steel Cleaner & Protectant (C-CLEANER). TUBE SYSTEM: Select Stainless Steel Cleaner & Protectant (C-CLEANER), and select one of these adhesives: Epoxy and Nozzle (LI-3701 & LI-3703), Non-Sag Adhesive (6100E-10AD), Environmentally Friendly Adhesive (EGEXTREME-10AD) | | |

Linear Wood Newel Applications

| | |
|---|--|
| Rake Up Newel (Cable: CR-410U) (Tube: TR-410U) | Use this newel as the starting newel on the first tread at the bottom of the stairway |
| Rake Pass Through/Center Newel (Cable: CR-420) (Tube: TR-420) | Use this newel on the stairs at 42"(cable)/48"(tube) intervals between the newels at the bottom and top of each flight |
| Level Start/Stop Newel (Cable: CL-410) (Tube: TL-410) | Use this newel at the beginning or end of each level run |
| Level Corner Newel (Cable: CL-410C) (Tube: TL-410C) | Use this newel at the corner of two level runs |
| Level Down Newel (Cable: CL-410D) (Tube: TL-410D) | Use this newel on the second floor landing at the top of the stairway flight |
| Level Pass Through/Center Newel (Cable: CL-420) (Tube: TL-420) | Use this newel on level runs midway between the Level Start/Stop, Corner and Down Newels at 42"(cable)/48"(tube) intervals |
| Blank Newel (Cable & Tube: B-400-48) | This newel is not pre-drilled and can be custom drilled at the jobsite and used at any level location |
| Rake Blank Newel (Cable & Tube: BR-400-48) | This newel is not pre-drilled and can be custom drilled at the jobsite and used at any rake location |

PHOTO PORTFOLIO



1 Open Tread Stair Panels, Level Run Panels, P-POSTKIT2H Panel Post Kits and Custom Handrail

2 Linear CABLE-SS Stainless Steel Cable, CL-MFTGS-SS Stainless Steel Level Run Cable Fittings, CL-310-36, CL-310C-36 and CL-320-36 Linear Metal Newel Posts and Custom Exterior Handrail

3 Linear TUBE-SS Stainless Steel Tube, LJ-4101 Newel Posts and Custom Handrail

4 Kneewall Stair Panels, Level Run Panels, LJ-4101G Newel Posts and Custom Handrail

5 Linear CABLE-SS Stainless Steel Cable, CL-WDFTGS-SS Level Run Stainless Steel Cable Fittings, LJ-6002 was used for Handrail and Newel Post

6 Linear TUBE-58-008-LSB Low Sheen Black Tube, LJ-4000 Newel Posts and 684 Handrail





Consult your local building code official before purchasing and installing any of these systems. Please contact your L.J. Smith dealer or representative if you have any questions about our Linear Collection products.

TOOLS LISTS

PANEL SYSTEM

Power Drill
Miter Saw
Hack Saw
Square or Phillips Screw Tip
5/32" Hex Driver or Allen Wrench
1/8", 3/16", 1/4", 3/8" Twist Bits

CABLE & METAL NEWELS SYSTEM*

Power Drill
1/8" Cable Cutter
Two 3/8" Open End Wrenches
1/2" Box End Wrench
3/16", 5/32" Allen Wrenches
1/8", 1/4" Twist Bits
#2 Phillips Drill Tip or Phillips
Screwdriver
Cable Release Tool

CABLE & WOOD NEWELS SYSTEM*

Power Drill
1/8" Cable Cutter
Two 3/8" Open End Wrenches
3/16" Allen Wrench
9/16" Wrench
5/16" Twist Bit
5/8" x 3" Flare Spade Bit
Cable Release Tool

TUBE & WOOD NEWELS SYSTEM

Power Drill
9/16" Wrench
5/16" Twist Bit
5/8" x 3" Flare Spade Bit

*The tension on the cables will need periodic adjustment by using two 3/8" open end wrenches as described in the installation instructions.



A NOVO Building Products Company

35280 Scio-Bowerston Road • Bowerston, Oh 44695
(740) 269-2221 • LJSmith.com