



TURNCRAFT®

THE WORLD'S FINEST COLUMNS AND POSTS



WE TURN OUT *Quality*

A LITTLE ABOUT US

- Began manufacturing wood columns in 1963
- Added wood porch posts in 1969.
- The Architectural division was added in 1989.
- Introduced the Poly-Classic® Composite Products in 1994.
- PVC Craftsman's Products added in 2004.
- Introduced the DuraGlass™ Pultruded Products in 2006.

Architects and builders have chosen Turncraft columns because of our thoughtful design, exceptional materials, fine workmanship, superior assembly, and extensive selection. Precise historical research and authentic architectural specifications reflect our dedication to the quality you can expect from all of our products from in-stock columns to custom-built solutions.



TURNCRAFT PRODUCTS MADE IN THE U.S.A



DID YOU KNOW?

- All Turncraft products, wood and composite, are manufactured in the U.S.A. in our own factories.
- Our experienced craftsmen take extreme care and pride in the products we produce for our customers, all the way from making our own molds to the finished products.
- Turncraft provides the largest selection of products from any manufacturer. Period!
- All Turncraft products are designed to work together for perfectly matched columns regardless of the type of materials used.



Table of Contents

How to select	4-5
Styles and Design Characteristics	5-9
Poly-Classic® FRP Columns	10
Product Information	11
TimeSaver Cap and Base	12
FRP Available Heights and Capacities	13
Round Tapered Columns	14
Round Tapered Cap and Base	15
Round Tapered Ornamental Capitals	16
Round Non-tapered with Cap and Base	17
Pro Series FRP Columns	18
Pro Series Cap and Base	19
Poly-Classic® DuraGlass™ columns	20
Product Information	21
Tapered Square with Cap and Base	22
Non-tapered Square with Cap and Base	23
Poly-Vinyl Porch Posts	24
Product Information	25
Poly-Classic® Craftsman Columns	26
Craftsman Introduction and E-Z Lock	27
Tapered Shafts with Cap and Base	28
Non-tapered Shafts with Cap and Base	29
Craftsman Rough-Sawn Columns	30
Pedestals and Newel Posts with Trim	31
Ornamental Capitals	32
Mix-N-Match	33
Turncraft Architectural Series	34
Wood Species Available	35
Greek Doric and Tuscan Specifications	36
Roman Doric and Ionic Specifications	37
Roman Corinthian Specifications	38
Load Capacities and Plan Types	38
Ornamental Capitals	39
Colonial Columns	40
Product Information	41
Colonial Tapered Round Columns	42
Cap and base/Ornamental Capitals	43
Square Wood Columns	44
Product Information	45
Wood Porch Posts	46
Product Information	47
Website	48
Quality at Every Turn	49

How to Select

Your Turncraft Column or Post (or which Turncraft column or post is right for you)

To determine which product is the best for your project, you'll want to consider several things: location, style, size, and plan type. Not all styles, sizes or plan types are made in all materials.

All Turncraft products (except the Craftsman Series) are manufactured whole and are designed to be load bearing. If you need to wrap an existing load support, all of our columns are able to be split in half at the factory or by the installer and re-assembled, or they can be split to be used as pilasters.

Craftsman Series columns are square, tapered or non-tapered, and are shipped KD (knocked-down) to be assembled around an existing load support. Craftsman Series pedestals are unique in that they may be used to add a pedestal look to any existing column, or combined with any of our other products to create a pedestal/column look.

I. Determine the location:

Where this product will be used – interior or exterior. All of our products are fine for interior use. Wood may be a more familiar material to work with, but all products can be installed with standard carpentry techniques and tools.

Best for exterior: Poly-Classic® products (low maintenance, lifetime warranty, waterproof), and Turncraft Architectural cedar columns. A large selection of styles are available. Poly-Classic® products require painting (except Poly-Classic® Porch Posts).

II. Determine the column line:

FRP Poly-Classic® FRP Column:

Fiberglass reinforced polymer are virtually maintenance-free. They are impervious to termites and carpenter ant attack as well as staining and decaying fungi. High-humidity environments have no effect on these non-porous, waterproof columns.

DGL Poly-Classic® DuraGlass™ Column:

Resin-infused or pultruded fiberglass made from lightweight fiberglass, these columns are easy to cut, easy to install, and strong enough to carry heavy loads. DuraGlass™ columns are decay resistant and require little maintenance.

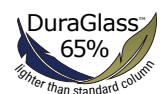

CRF Poly-Classic® Craftsman Series:

PVC-expanded cellular poly-vinyl-chloride are manufactured using expanded cellular PVC and can be trimmed, fastened and drilled with ordinary woodworking tools. Craftsman Series Columns are manufactured using our E-Z Lock Miter Joint that aids in assembly.



PVP Poly-Vinyl Porch Post:

Galvanized steel square core and sturdy inserts at critical connection points. Constructed from seamless window grade vinyl with UV inhibitor. Delivered with matte white finish, but can be painted to match your project.

ARC *Turncraft Architectural:*

Exterior columns are usually made of cedar or pine. Cedar have a 10 year limited warranty, and pine has a 1 year limited warranty. Exterior wood products require painting. Turncraft Architectural also provides our most complete selection of styles and sizes, including interior stain grade columns.



COL *Colonial Column:*

Used for interior and exterior installations. Column shafts are manufactured from finger-joint pine, and unless factory primed, are immersion treated in Woodlife® 111. Ready to prime and paint.



SWC *Square Wood Column:*

Used for interior and exterior installations. Column shafts are manufactured from finger-joint pine, and unless factory primed, are immersion treated in Woodlife® 111. Ready to prime and paint.



WPP *Wood Porch Post:*

Made from select kiln-dried finger-jointed woods, and are precision moulded, glued with Type-I waterproof glue. Sanded and primed with special sealer applied to bottom of post for easy installation.



III. Determine the style.

Perhaps most important, is of course style. This includes the classical orders of architecture: Greek Doric, Tuscan, Roman Doric, Ionic and Corinthian, with the addition of our own Colonial style. All round columns are available plain or fluted (except DuraGlass™), and most square columns are available plain, fluted or with panels.

Greek Doric

Available in:

ARC *Architectural Wood*
(pages 36-41)

BRING HOME THE ELEGANCE OF THE PARTHENON.

The Greek Doric Order is unique among column styles with its absence of a base and astragal. The column height in ratio to its diameter varies greatly when viewed in antiquity: the architectural proportions can range from four to six diameters. Normally fluted, the Greek Doric has twenty flutes, with no fillets, so the flutes come to a peak (arris flutes). The depth of the flute is approximately one-sixth of the flute width. Greek Doric columns are most commonly recognized as those found on the Parthenon in Athens.





Tuscan

Available in:



Poly-Classic® FRP
(pages 10–19)



DuraGlass™ Fiberglass
(pages 22–25)



Craftsman PVC
(pages 28–35)



Architectural Wood
(pages 28–35)

SIMPLICITY GIVES YOUR DESIGN CENTER STAGE.

The distinguishing characteristic of the Tuscan Order is simplicity. Seldom fluted, the minimal mouldings and stylishly clean lines provide a robust appearance. When used in true architectural proportions, the height of the column, including cap and base, is seven diameters. Tuscan columns in antiquity are found on the Temple of Piety in Rome.



Roman Doric

Available in:



Poly-Classic® FRP
(pages 10–19)



Architectural Wood
(pages 28–35)

CLASSIC DESIGN REACHES NEW HEIGHTS.

The Roman Doric order features an increase of decorative moulding over the Tuscan Order. Vignola's Denticulated Doric Cap has a stepped, three-fillet support of the echinus instead of the single-fillet support of the Tuscan Order. The Doric base is similar to the Tuscan, but the addition of a bead above the torus moulding is an elegant embellishment. According to Vignola, the height of the Doric Column, including cap and base, should be eight diameters. Vignola Denticulated Doric is imitated closely from the Roman Theater of Marcellus.

Ionic

Available in:



Poly-Classic® FRP
(pages 10–19)



Craftsman PVC
(pages 28–35)



Architectural Wood
(pages 28–35)

ADDED EMBELLISHMENTS CREATE IMPRESSIVE SPACES. Embellishing the Ionic Order are ornate scrolls decorating the capital of the column. These scrolls derive their intriguing shape from the Nautilus shell. We include the Temple of Winds and Roman Doric Ornamental capitals, with their intricate designs, in our Ionic styles. Most commonly, Ionic columns incorporate twenty-four flutes separated by fillets that are about one-half the flute width. Customarily, the Ionic Order column height, including capital and base, is nine diameters. A prime example of the Ionic Order as it was used in Rome is the Temple of Fortuna Virilis.



Corinthian

Available in:



Poly-Classic® FRP
(pages 10–19)



Craftsman PVC
(pages 28–35)



Architectural Wood
(pages 28–35)

MAKE IT THE CROWNING JEWEL OF YOUR PROJECT. Columns of the Corinthian Order are crowned with an inverted bell-shaped capital. The capital is richly adorned with Acanthus leaves. This column is almost always fluted. Like the Ionic, the Corinthian column exhibits twenty-four flutes and an Attic Base. The height of Corinthian columns, including capital and base, is ten diameters. This is a common Roman order that was used on the Temple of Mars Ultor.





Arts and Crafts

Available in:



Craftsman PVC
(pages 28–35)



DuraGlass™ Fiberglass
(pages 22–25)

THE STYLE IS TIMELESS. NOW THE COLUMN IS TOO.

Born out of the understated, practical tradition of the early 1900's Arts and Crafts movement, the square tapered column has become popular in modern adaptations of the Craftsman, Prairie, Bungalow, Country, and Mission style homes of today. Also available non-tapered, this timeless style is manufactured from expanded cellular PVC for quick, easy assembly and virtually maintenance-free performance! Now you can recapture the simple, honest artistry of yesterday's craftsman with today's most advanced materials and construction techniques.



Colonial Wood

Available in:



Colonial Wood
(pages 42–45)

ELEGANT NEW WORLD ENHANCEMENTS FOR YOUR HOME.

As with many iconic Old World items, New World designers have taken the basic column concept and adorned it with a unique, more contemporary style. The Colonial style redefines the column with simplicity, yet retains the elegance desired to make bold statements for entryways and interiors. Available smooth or fluted, the entire line of ornamental capitals is also available for personalizing the column to fit any décor.

Porch Posts

Available in:



Porch Posts Wood
(pages 46-47)



Porch Posts Vinyl
(pages 26-27)

AN ALL-AMERICAN DECORATIVE TRADITION.

When a column would simply be too much, but a decorative touch is essential, a Porch Post from Turncraft would be the perfect choice. Often featured on Farmhouse and Country style houses with their spacious porches, and Victorian homes with their intricate details, the Colonial pattern is a traditional favorite. Porch Posts add charm and personality to walkways, landings, decks, and porches. There is nothing like the beauty of a Porch Post to add distinction and character to any home.



Pro-Series

Available in:



Poly-Classic® FRP
(page 18)

The New Square Pro-Series FRP Columns is lighter and cost less with the same load bearing capacity as the Standard Square FRP Column.



POLY-CLASSIC®

FRP

FRP Columns

- STRONGEST COLUMN AVAILABLE
- LIMITED LIFETIME WARRANTY
- LOW MAINTENANCE
- READY TO PRIME AND PAINT
- WIDE ARRAY OF OPTIONS
- EXTERIOR OR INTERIOR USE
- CAN BE SPLIT FOR REASSEMBLY
- MADE WITH FLAME GUARD™

POLY-CLASSIC® FRP COLUMNS

Turncraft Poly-Classic® FRP Columns are the product of choice for homeowners and builders who demand beauty, value, and performance. Poly-Classic® FRP Columns are architecturally proportioned from rotocast fiberglass-reinforced polymer — the most advanced construction material in the world — so pound for pound they are stronger than concrete, steel, or aluminum.

LIMITED LIFETIME WARRANTY

Poly-Classic® FRP Columns are virtually maintenance-free. They are impervious to termite and carpenter ant attack as well as staining and decaying fungi. High-humidity environments have no effect on these non-porous, waterproof columns. All Turncraft Poly-Classic® Columns are covered by a limited lifetime warranty to the original purchaser. Warranty details are available from your distributor or our website-www.Turncraft.com.

PLAN TYPES

Poly-Classic® FRP Columns are available in the plan types below. Please specify when you order. (Fractional components shown are typical. Customer may specify actual returns, wall thicknesses, etc.)

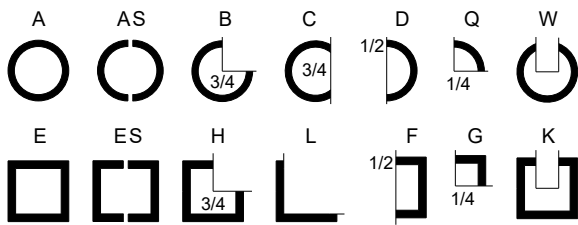

FRP
Tuscan
Tapered
Round
Smooth

FRP
Tuscan
Tapered
Round
Fluted

FRP
Tuscan
Non-Tapered
Round
Smooth

FRP
Tuscan
Non-Tapered
Round
Fluted

Pro-Series
Tuscan
Non-tapered
Square
Smooth

Pro-Series
Tuscan
Non-Tapered
Square
Fluted

Pro-Series
Tuscan
Non-Tapered
Square with
Pedestal

TURNCRAFT EXCLUSIVES PRODUCTS

TIMESAVER CAP AND BASE

New to the Turncraft product line, our 8" Square TimeSaver Cap and Base employs the same Quick-Fit installation pressure tabs as our round 8", 10", and 12" TimeSaver products. Our TimeSaver cap and base offers the easiest and quickest installation in the industry.



- Made out of fiber-reinforced recycled ABS (acrylonitrile butadiene styrene)
- Designed for use on round FRP columns in 8", 10", and 12" sizes
- Made with 95% recycled material
- Extremely strong and durable
- Self aligning with no fasteners
- Excellent paint adhesion
- Fast installation

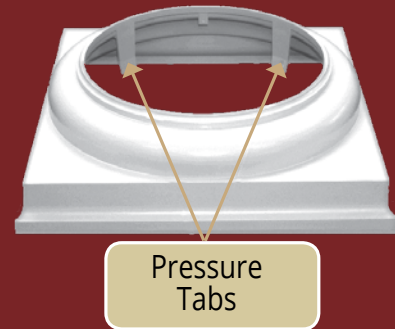

TIMESAVER RAILING ADAPTER BRACKET

Our TimeSaver railing adapter bracket solves the age old problem of attaching a railing system to the decorative base of a round column. Simply use one of these new brackets to make an attractive attachment to our 8", 10", and 12" round Tuscan bases. Brackets are available in two different heights, allowing them to be used with just about any railing system on the market.

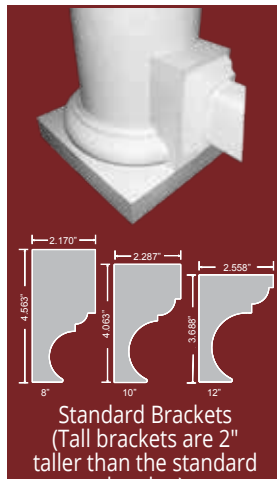

COPPER OR ALUMINUM FLASHING

Turncraft is now offering real flashing for our most popular sizes of columns - the 8", 10", and 12" round and square Poly-Classic® FRP columns with Tuscan caps. Flashing is available in either copper or aluminum. Flashing is 3/4" larger than abacus size, to be folded over the edges of the cap, held in place with construction adhesive (not supplied). Flashing for other sizes and styles of caps are available. Call for more information.

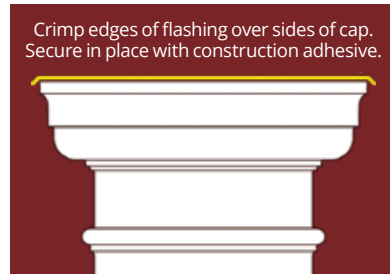

INSTALL KIT

For structural FRP columns, the install kit consists of 4 ABS brackets (2 for top of column and 2 for bottom) and fasteners required for standard installation. We recommend 2 kits for columns 16" and up: this will allow the installer to use 4 brackets at the top and bottom of the column. When installed, the cap and base will conceal these brackets and hardware.



SPLIT KIT

Each kit contains six nylon locking straps with 1/8" spacers and one quart (1.85 lb.) automotive body filler. For columns over 12 foot in height, two kits will be required per column. Turncraft recommends using an abrasive (Carborundum or similar) or carbide blade to trim the shaft. Split columns are not load bearing.



ROUND TAPERED AND NON-TAPERED COLUMNS

Available fluted and unfluted in a wide range of sizes. Flutes in most 8", 10", and 12" diameter tapered shafts are molded right into the shaft, providing consistent Ionic fluting. All sizes can also be custom-fluted for specific opening heights, and adjusted for the cap and base chosen. When shafts are custom fluted, typically the flutes end 1" from the top of the base.

Tapered Round FRP Shafts Available Heights and Load Capacities														
Column Bottom Diameter ‡	5'	6'	8'	9'	10'	12'	14'	16'	18'	20'	22'	24'	Concentric Load *	Eccentric Load *
6"	✓	✓	✓										6,000 lb.	6,000 lb.
8"	✓	✓	✓•	✓•	✓•								10,000 lb.	6,600 lb.
10"	✓	✓	✓•	✓•	✓•	✓•							14,000 lb.	10,720 lb.
12"	✓	✓	✓•	✓•	✓•	✓•	✓	✓•					18,000 lb.	13,200 lb.
14"			✓	✓	✓	✓	✓	✓	✓	✓			20,000 lb.	11,520 lb.
16"	✓	✓	✓	✓	✓	✓	✓	✓	✓	✓			20,000 lb.	13,200 lb.
18"			✓	✓	✓	✓	✓	✓	✓	✓	✓	✓	20,000 lb.	9,040 lb.
20"		✓	✓		✓	✓	✓	✓	✓	✓			20,000 lb.	18,960 lb.
24"			✓		✓	✓	✓	✓	✓	✓	✓	✓	20,000 lb.	13,200 lb.

Non-Tapered Round Shafts Available Heights and Load Capacities								
Column Bottom Diameter ‡	8'	10'	11'	12'	14'	15'	Concentric Load *	Eccentric Load *
8"	✓	✓					10,000 lb.	8,240 lb.
10"	✓	✓					14,000 lb.	11,520 lb.
12"	✓	✓		✓			18,000 lb.	11,520 lb.
14"	✓	✓		✓	✓		20,000 lb.	18,120 lb.
16"	✓	✓					20,000 lb.	13,200 lb.
18"	✓	✓	✓				20,000 lb.	9,040 lb.
20"	✓	✓	✓				20,000 lb.	18,960 lb.
24"	✓	✓		✓	✓	✓	20,000 lb.	13,200 lb.

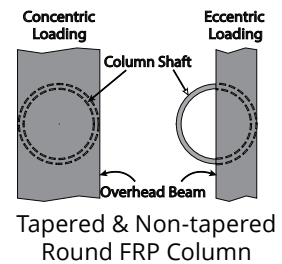

PRO SERIES SQUARE NON-TAPERED COLUMNS

Available unfluted or fluted. Shaft does NOT have molded astragal (astragal ships with Tuscan cap/base.)

Non-Tapered Square Shafts Available Heights and Load Capacities								
Column Bottom Width	8'	9'	10'	12'	14'	16'	Concentric Load *	Eccentric Load *
6"	✓Δ	✓Δ	✓Δ				6,000 lb.	6,000 lb.
8"	✓Δ	✓Δ	✓Δ	✓Δ			10,000 lb.	10,000 lb.
10"	✓Δ	✓Δ	✓Δ	✓Δ			12,800 lb.	12,800 lb.
12"	✓Δ	✓Δ	✓Δ	✓Δ	✓Δ	✓Δ	18,000 lb.	17,320 lb.

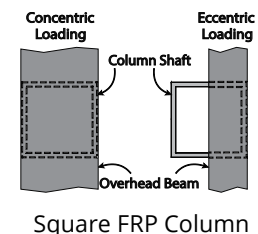

All Poly-Classic® FRP Columns are available with custom fluting.

- ✓ Available Unfluted.
- Available Standard Flute
- Δ Available Custom Flute

‡ Actual shaft width may be smaller than nominal size shown.

* Load capacities are reduced when loads are not centered. Full documentation regarding eccentric load capacities can be found online at turncraft.com. Please refer to the online documentation regarding maximum eccentricity (beam offset from center) and other specifications.

FRP ROUND TAPERED COLUMN SPECIFICATIONS

Column Nominal Diameter	Shaft Height	Shaft Bottom *		Shaft Top *		Space Available Inside Shaft		Shaft Neck		Flute Width (24 each)	Straight Portion of Shaft (unfluted)	Straight Portion of Shaft (fluted)	Smooth Shaft before Flutes												
		Outside Diameter	Inside Diameter	Outside Diameter	Inside Diameter	For Round Post	For Square Post	Neck height †	Astragal Ring ‡																
	A	C	D	H	I			G	F		B	B	E												
6"	5'	5 11/16"	4 3/4"	4 13/16"	3 3/4"	3 3/8"	2 1/2"	3"	1/2"	1/2"	23 1/16"	n/a	n/a												
	6'										35 1/16"														
	8'										59 1/16"														
8"	5'	7 5/8"	6 3/4"	6 19/32"	5 1/2"	5 1/8"	3 1/2"	4 1/4"	1/2"	11/16"	14 1/16"	n/a	n/a												
	6'										26 1/16"														
	8'										50 1/16"														
	9'										62 1/16"														
	10'										72 1/16"														
10"	4'	9 11/16"	8 3/8"	8 9/16"	7 3/4"	7 3/8"	4 15/16"	5 1/8"	3/4"	7/8"	0	n/a	n/a												
	5'										0														
	6'										10 11/16"														
	8'										34 11/16"														
	9'										46 11/16"														
	10'										58 11/16"														
12"	5'	11 5/8"	10 3/4"	10 1/16"	9 1/4"	8 7/8"	6"	4 3/4"	3/4"	1"	0	n/a	n/a												
	6'										8 3/4"														
	8'										32 3/4"														
	9'										42 3/4"														
	10'										44 3/4"														
	12'										49"														
	14'										53"														
	16'										60"														
	18'										62"														
	20'										86"														
14"	8'	13 1/2"	11 1/2"	11 9/16"	10 1/2"	10 1/8"	6 3/8"	6 3/4"	1"	1 1/4"	33 1/4"	42 3/4"	11 1/4"												
	9'										45 1/4"														
	10'										57 1/4"														
	12'										81 1/4"														
	14'										57 1/4"														
	16'										81 1/4"														
	18'										105 1/4"														
	20'										129 1/4"														
	16"										5'			15 7/16"	13 1/2"	13 1/8"	12"	11 5/8"	7 7/16"	7 3/8"	1"	1 7/16"	16 1/4"	42 3/4"	11 1/4"
											6'												28 1/4"		
8'		18 1/2"																							
9'		30 1/2"																							
10'		42 1/2"																							
12'		66 1/2"																							
14'		27 1/4"																							
16'		51 1/4"																							
18'		75 1/4"																							
20'		99 1/4"																							
18"	8'	17 3/8"	15"	14 5/16"	12 3/4"	12 3/8"	8 5/16"	7 7/8"	1"	1 1/2"	13 3/8"	42 3/4"	11 1/4"												
	9'										25 3/8"														
	10'										37 3/8"														
	12'										61 3/8"														
	14'										85 3/8"														
	16'										26 1/8"														
	18'										50 1/8"														
	20'										74 1/8"														
	22'										98 1/8"														
	24'										122 1/8"														
20"	6'	19 3/8"	18"	16 5/16"	14 7/8"	14 1/2"	10"	9 3/16"	1 3/8"	1 11/16"	0	42 3/4"	11 1/4"												
	8'										22 1/4"														
	10'										46 1/4"														
	12'										70 1/4"														
	14'										40 3/8"														
	16'										64 3/8"														
	18'										88 3/8"														
	20'										112 3/8"														
24"	8'	23 3/8"	22"	19 5/16"	18"	17 5/8"	12 3/16"	12"	1 5/8"	2 1/8"	8"	42 3/4"	11 1/4"												
	10'										32"														
	12'										56"														
	14'										24 13/16"														
	16'										48 13/16"														
	18'										72 13/16"														
	20'										96 13/16"														
	22'										120 13/16"														
	24'										144 13/16"														

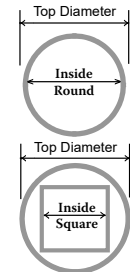

The "Space Available Inside Shaft" measurements are calculated at the top inside diameter (with ± 3/8" tolerance), when using Tuscan or Roman Doric caps. Fluted columns will have reduced tolerances.

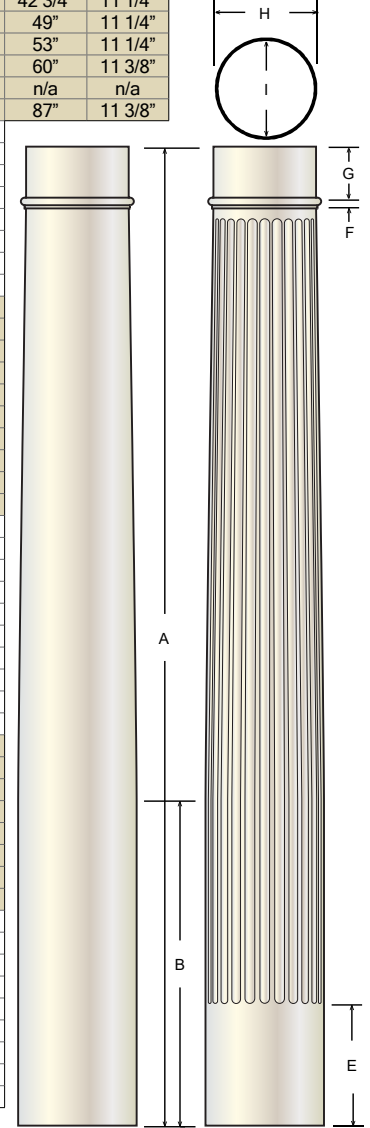

Refer to page 13 for Concentric and Eccentric load capacities.

* Diameters may vary ± 1/8".

† Neck Height is the distance from the top of the shaft to the top of the astragal ring, ± 1/8".

‡ Astragal ring is only the ring portion, and does not include the fillet and cove.

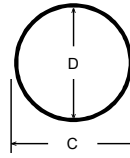

All caps, bases, and ornamental capitals are manufactured of low-maintenance materials. Materials for caps and bases will vary based on size and style. Standard Tuscan caps and bases for our 8", 10", and 12" diameter round tapered columns are our new TimeSaver ABS (recycled ABS with fiberglass reinforcement). Since these are molded products, specifications shown are ± 1/8", and subject to change without notice.

TUSCAN CAPS AND BASES

Column Diameter	Tuscan Base					Tuscan Cap				Materials Available †
	Plinth		Torus		Height	Echinus	Abacus		Height	
	A	B	C	D	B-D	E	F	G	E-F	
6"	8"	1 1/2"	1 1/4"	1/2"	3 1/4"	1"	11/16"	7 1/2"	2 1/16"	<u>FP</u>
8"	10 7/8"	1 7/8"	1 3/4"	5/8"	4 1/4"	15/16"	1 3/8"	9 7/8"	2 11/16"	<u>A</u> <u>FP</u>
10"	13 1/2"	2 3/8"	2 1/8"	3/4"	5 1/4"	1 13/16"	1 3/4"	12 1/8"	3 9/16"	<u>A</u> <u>FP</u>
12"	16 1/4"	2 3/4"	2 3/8"	7/8"	6"	1 7/8"	2"	14 5/8"	3 7/8"	<u>A</u> <u>FP</u>
14"	18 5/8"	3 5/16"	3"	1"	7 5/16"	2 1/2"	2 5/16"	17"	4 15/16"	<u>FP</u>
16"	21 5/16"	3 7/8"	3 3/8"	1 1/8"	8 5/16"	2 3/4"	2 11/16"	19 1/8"	5 7/16"	<u>FP</u>
18"	24"	4 3/16"	4"	1 3/8"	9 9/16"	3"	2 15/16"	21 15/16"	5 15/16"	<u>FP</u>
20"	27"	4 3/4"	4 1/16"	1 3/4"	10 9/16"	3 1/8"	3 7/16"	24 1/4"	6 9/16"	<u>P</u>
24"	32 1/2"	5 3/4"	5 1/4"	2 1/4"	13 1/4"	3 5/16"	4 1/8"	28 3/4"	7 7/16"	<u>P</u>

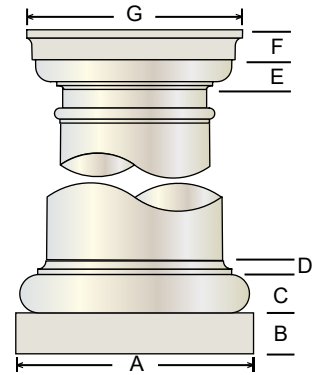

† A-ABS TimeSaver, E-FRP, P-Polyurethane cap with FRP base; standard material is underlined.

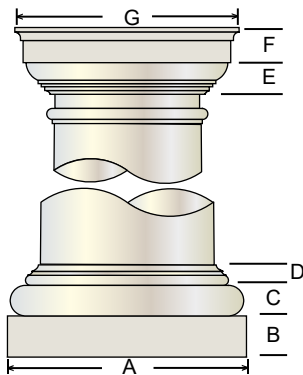

ROMAN DORIC CAPS

Column Diameter	Roman Doric Base †					Roman Doric Cap †			
	Plinth		Torus		Height	Echinus	Abacus		Height
	A	B	C	D	B-D	E	F	G	E-F
6"	7 31/32"	1 1/2"	1"	3/4"	3 1/4"	1"	1 1/4"	8"	2 1/4"
8"	10 7/8"	1 7/8"	1 7/16"	15/16"	4 1/4"	1 7/16"	1 1/2"	10 1/4"	2 15/16"
10"	13 1/2"	2 3/8"	1 3/4"	1 1/4"	5 3/8"	1 7/8"	1 3/4"	13"	3 5/8"
12"	16 1/8"	2 3/4"	2 1/16"	1 3/8"	6 3/16"	2 1/8"	2 3/8"	15 1/8"	4 1/2"
14"	18 3/4"	3 3/8"	2 3/8"	1 5/8"	7 3/8"	2 11/16"	2 3/4"	17 13/16"	5 9/16"
16"	21 1/2"	3 7/8"	2 7/8"	2"	8 3/4"	3 3/16"	3 1/8"	20 5/16"	6 5/16"
18"	24 1/4"	4 1/8"	3 5/16"	2 3/8"	9 7/8"	3 1/2"	3 9/16"	22 1/2"	7 1/16"

† Bases are FRP, caps are polyurethane.

OPTIONAL ATTIC BASES

Column Diameter	Plinth		Torus				Height
	A	B	C	D	E	F	B-F
6"	8"	1"	3/4"	3/4"	1/2"	1/2"	3 1/2"
8"	10 7/8"	1 7/8"	1 1/8"	7/8"	3/4"	1/2"	5 1/8"
10"	13 1/4"	2 3/8"	1 1/4"	1 1/8"	7/8"	5/8"	6 1/4"
12"	16 1/8"	2 3/4"	1 1/2"	1 3/8"	1"	5/8"	7 1/4"
14"	18 1/2"	3 5/16"	1 3/4"	1 5/8"	1 1/4"	11/16"	8 21/32"
16"	21 3/16"	3 3/4"	2 1/8"	1 7/8"	1 1/2"	13/16"	10 1/8"
18"	23 15/16"	4 1/4"	2 5/16"	2 1/8"	1 7/16"	1 1/8"	11 1/4"
20"	27 1/16"	4 3/4"	2 11/16"	2 3/8"	1 3/4"	1 7/16"	13"
24"	32 1/2"	5 3/4"	3 5/16"	2 13/16"	2 1/8"	1 3/4"	15 3/4"

Attic bases are FRP.

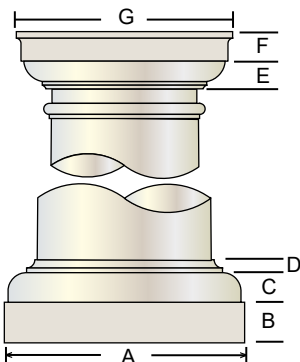
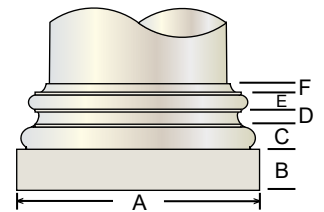

PRO SERIES CAPS AND BASES

Column Diameter	Pro Series Base †					Pro Series Cap †			
	Plinth		Torus		Height	Echinus	Abacus		Height
	A	B	C	D	B-D	E	F	G	E-F
8"	10 7/8"	1 7/8"	1 1/4"	5/8"	3 3/4"	1 1/4"	1 1/4"	9 7/16"	2 1/2"
10"	13 1/2"	2 3/8"	1 5/8"	9/16"	4 9/16"	1 13/16"	1 3/4"	12 3/16"	3 9/16"
12"	16 1/4"	2 3/4"	2"	7/8"	5 5/8"	1 7/8"	2"	14 5/8"	3 7/8"

† Cap and base are polystyrene (with foam core).

CAPITALS FOR FRP ROUND TAPERED COLUMNS

Our standard round capitals install on top of the column and are set on the fillet or the neckring. Capitals are either load-bearing or will include a load-bearing plug.



Empire



Empire with Necking



Greek Angular Ionic



Greek Erectheum



Greek Erectheum with Necking



Modern Composite



Roman Corinthian



Roman Doric Ornamental



Roman Ionic



Scamozzi



Temple of Winds

Shaft Nominal Bottom Diameter	Empire				Empire with Necking				Greek Angular Ionic				Greek Erectheum			
	Capital Height	Abacus Width	Scroll Width	Height Adjust *	Capital Height	Abacus Width	Scroll Width	Height Adjust *	Capital Height	Abacus Width	Scroll Width	Height Adjust *	Capital Height	Abacus Width	Scroll Width	Height Adjust *
6"	3 1/2"	9 3/8"	9 1/2"	-5/8"	6 7/8"	9"	8 3/4"	+3 1/4"	3 5/8"	9 1/4"	9"	+1/2"	3 1/4"	6 3/4"	8 1/2"	-7/8"
8"	3 7/8"	10 1/8"	10 1/8"	-7/8"	7 3/4"	10"	9"	+3 1/2"	4 1/8"	9 3/8"	9 5/8"	+5/8"	3 7/8"	7 3/4"	11 3/4"	-1"
10"	5 5/8"	14 1/8"	14 1/2"	-1/4"	10"	13 1/2"	12 1/4"	+4 7/8"	5 7/8"	14 1/2"	15 1/2"	0"	5 5/8"	12"	17 1/2"	-3/8"
12"	6 3/8"	17 3/4"	18 1/8"	+7/8"	11"	18"	17"	+6 1/4"	6"	17 1/4"	18 1/4"	+1/2"	7 1/4"	14 1/2"	21"	+3/4"
14"	7 1/2"	20 3/8"	21 1/2"	-1/2"	14 1/2"	20 1/2"	19 1/2"	+7 1/2"	7 1/4"	20 3/4"	19 1/4"	-3/4"	7"	15"	21"	-1"
16"	8 1/2"	21 3/4"	23"	+3/8"	17"	23"	19 1/2"	+9 7/8"	8 3/8"	20 1/2"	19 1/2"	+1/4"	9 1/4"	17 1/2"	26"	+7/8"
18"	10"	30 3/4"	26 1/4"	+3/4"	15"	32"	26 1/4"	+6 3/4"	9 3/4"	24 1/4"	19 3/4"	+1/2"	10 1/2"	22"	29"	+1 1/4"
20"	11 1/4"	34"	28"	+1 1/8"	17 1/4"	34"	28"	+8 1/2"	11"	29 3/4"	28"	+7/8"	11"	26"	36"	+7/8"
24"	12 3/4"	35 1/2"	35"	-1 1/8"	19"	35 1/2"	35"	+6 3/4"	12 3/4"	35"	34 1/2"	-1 1/8"	13"	30 1/2"	43"	-7/8"

Shaft Nominal Bottom Diameter	Greek Erectheum with Necking				Modern Composite			Roman Corinthian			Roman Doric Ornamental			
	Capital Height	Abacus Width	Scroll Width	Height Adjust *	Capital Height	Abacus Width	Height Adjust *	Capital Height	Abacus Width	Height Adjust *	Capital Height	Abacus Width	Scroll Width	Height Adjust *
6"	5 3/4"	7 3/4"	11 3/4"	+2 1/8"	7"	8"	+3 3/8"	7 1/8"	9 3/8"	+3 1/2"	4 1/8"	8 3/4"	n/a	0"
8"	7 1/2"	10 1/2"	15"	+3 1/4"	8 1/2"	10 3/4"	+4 1/4"	8 7/8"	12 3/8"	+4 5/8"	6"	13 1/8"	n/a	+1 1/4"
10"	8 1/2"	12"	17 1/4"	+3 3/8"	13 5/8"	14 5/8"	+8 1/2"	11 5/8"	14 3/4"	+6 1/2"	6"	14 3/8"	n/a	+1/8"
12"	9 1/2"	14 1/2"	21"	+4 3/4"	14 1/2"	19"	+9 3/4"	14 5/8"	17 3/4"	+9 7/8"	7 1/8"	16 1/8"	n/a	+1"
14"	11 1/4"	15"	21"	+4 1/4"	17"	20"	+10"	17 1/8"	22 1/2"	+10 1/8"	7 1/4"	17 5/8"	n/a	0"
16"	13 1/2"	17 1/2"	26"	+6 3/8"		n/a		17 3/8"	23 5/8"	+10 1/4"	7 7/8"	23 5/8"	n/a	+2 3/4"
18"	15"	22 1/2"	29"	+6 3/4"	22 1/2"	25"	+14 1/4"	21 1/8"	28"	+12 7/8"	12 1/2"	28"	n/a	+3 1/4"
20"	17"	26"	36"	+8 1/4"	22 1/2"	25"	+13 3/4"	24 3/4"	38 1/2"	+16"	12 1/2"	28"	24"	+1 3/8"
24"	19"	30 1/2"	43"	+6 3/4"		n/a		27 3/4"	42"	+15 1/2"		n/a		

Shaft Nominal Bottom Diameter	Roman Ionic				Scamozzi				Temple of Winds		
	Capital Height	Abacus Width	Scroll Width	Height Adjust *	Capital Height	Abacus Width	Scroll Width	Height Adjust *	Capital Height	Abacus Width	Height Adjust *
6"	2 1/4"	6 1/4"	8 1/4"	-1 7/8"	2 1/2"	8 1/8"	7 3/4"	-1 5/8"	7 7/8"	7 7/8"	+4 1/4"
8"	3 5/8"	8"	9 7/8"	-1 1/8"	3"	10 1/4"	9"	-1 3/4"	7 1/2"	10 1/2"	+3 1/4"
10"	4"	11 1/2"	14 1/2"	-1 7/8"	4 3/8"	14 5/8"	14 1/8"	-1 1/2"	10 1/8"	14 1/2"	+5"
12"	4 3/4"	12 7/8"	16"	-3/4"	5 1/8"	16 1/4"	15 5/8"	+3/8"	11 1/4"	16 1/2"	+6 1/2"
14"	5 5/8"	17 3/8"	22 3/4"	-2 3/8"	5 3/4"	18 1/2"	18 5/8"	-2 1/4"	14"	21"	+7"
16"	6 3/8"	18"	22"	-1 3/4"	5 7/8"	21 3/8"	21 3/4"	-2 1/4"	16 3/8"	22 3/4"	+9 1/4"
18"	6 3/8"	18"	22"	-2 7/8"	7 3/8"	24 1/4"	23 1/2"	-1 7/8"	18 3/8"	26"	+10 1/8"
20"	9 1/4"	25 1/8"	31 3/8"	-9/16"	7 1/2"	25 7/8"	25 3/8"	-2 5/8"	21 3/8"	28 3/8"	+12 5/8"
24"	9"	25"	32 5/8"	-4 7/16"	10 1/4"	34 1/4"	29 1/2"	-3 3/16"	26"	30 7/8"	+13 3/4"

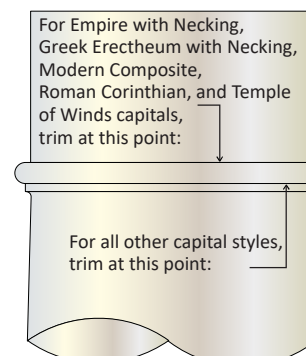

* "Height adjust" column is the adjustment to overall height when using this capital on a column trimmed for architecturally correct installation.

Highlighted sizes are not load bearing and will require a plug. Height shown does not include plug.

POLY-CLASSIC® SHAFTS FOR ROUND NON-TAPERED FRP COLUMNS

Standard FRP column shafts are the same height as the listed size. Tuscan caps and bases and Attic bases go around the shaft, and do not affect the overall height. Ornamental capitals are not typically available for non-tapered round shafts.

Column Nominal Diameter	Shaft Height	Shaft Diameters *		Space Available Inside Shaft		Flute Width (24 each)	Concentric Load	Eccentric Load
		Outside Diameter	Inside Diameter	For Round Post	For Square Post			
		A	B	C				
8"	8'	7 5/8"	6 3/4"	6 3/8"	4 1/2"	11/16"	10,000 lb.	6,600 lb.
	10'							
10"	8'	9 11/16"	8 3/8"	8"	5 5/8"	7/8"	14,000 lb.	10,720 lb.
	10'							
12"	8'	11 5/8"	10 3/4"	10 3/8"	7 5/16"	1"	18,000 lb.	13,200 lb.
	10'							
	12'							
14"	8'	13 1/2"	11 1/2"	11 1/8"	7 7/8"	1 5/16"	20,000 lb.	11,520 lb.
	10'							
	12'							
	14'							
16"	8'	15 7/16"	13 1/2"	13"	9 3/16"	1 1/2"	20,000 lb.	13,200 lb.
	10'							
18"	8'	17 3/8"	15"	14 1/2"	10 1/4"	1 11/16"	20,000 lb.	9,040 lb.
	10'							
	11'							
20"	8'	19 3/8"	18"	16 1/2"	11 5/8"	1 7/8"	20,000 lb.	18,960 lb.
	10'							
	11'							
24"	8'	23 3/8"	21 1/4" (top ID)	19 1/2"	13 3/4"	2 5/16"	20,000 lb.	13,200 lb.
	10'							
	12'							
	14'							
	15'							

* Diameters may vary ± 1/8".

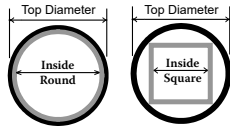

The "Space Available Inside Shaft" measurements are calculated at the top inside diameter (with ± 3/8" tolerance) when using Tuscan or Roman Doric caps. Fluted columns may have reduced tolerances.

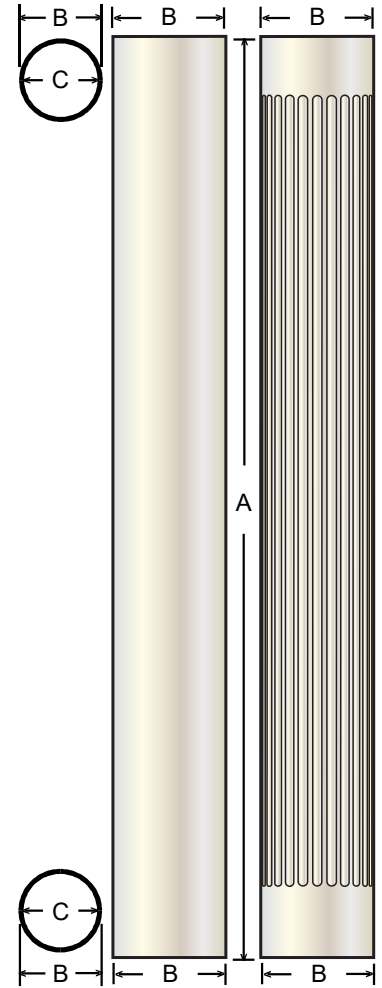

TUSCAN CAPS AND BASES

Column Diameter	Tuscan Base						Tuscan Cap				
	Plinth		Torus		Height	Materials Available *	Echinus	Abacus		Height	Materials Available *
	A	B	C	D	B-D		E	F	G	E-F	
8"	10 7/8"	1 7/8"	1 3/4"	5/8"	4 1/4"	<u>A</u> , F	1 13/16"	1 3/4"	12 1/8"	3 9/16"	<u>P</u>
10"	13 1/2"	2 3/8"	2 1/8"	3/4"	5 1/4"	<u>A</u> , F	1 7/8"	2"	14 5/8"	3 7/8"	<u>P</u>
12"	16 1/4"	2 3/4"	2 3/8"	7/8"	6"	<u>A</u> , F	2 1/2"	2 5/16"	17"	4 13/16"	<u>P</u>
14"	18 5/8"	3 5/16"	3"	1"	7 5/16"	<u>E</u>	2 3/4"	2 11/16"	19 1/8"	5 7/16"	<u>P</u>
16"	21 5/16"	3 7/8"	3 3/8"	1 1/8"	8 5/16"	<u>E</u>	3"	2 15/16"	21 5/16"	5 15/16"	<u>P</u>
18"	24"	4 3/16"	4"	1 3/8"	9 9/16"	<u>E</u>	3 1/8"	3 7/16"	24 1/4"	6 9/16"	<u>P</u>
20"	27"	4 3/4"	4 1/16"	1 3/4"	10 9/16"	<u>E</u>	3 3/16"	4 1/8"	28 3/4"	7 5/16"	<u>P</u>
24"	32 1/2"	5 3/4"	5 1/4"	2 1/4"	13 1/4"	<u>E</u>	3 5/16"	4 1/8"	32 1/2"	7 7/16"	<u>P</u>

* A-ABS, F-FRP, P-Polyurethane; standard material is underlined.

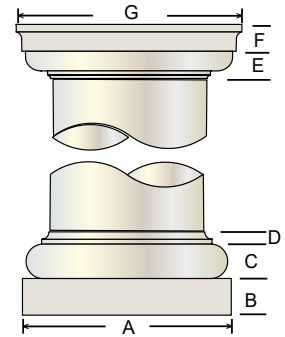

OPTIONAL ATTIC BASES

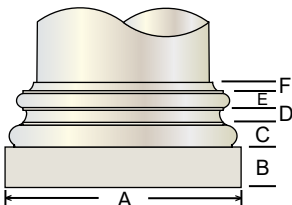

Column Diameter	Attic Base						
	Plinth		Torus				Height
	A	B	C	D	E	F	B-F
8"	10 7/8"	1 7/8"	1 1/8"	7/8"	3/4"	1/2"	5 1/8"
10"	13 1/2"	2 3/8"	1 1/4"	1 1/8"	7/8"	5/8"	6 1/4"
12"	16 1/8"	2 3/4"	1 1/2"	1 3/8"	1"	5/8"	7 1/4"
14"	18 1/2"	3 5/16"	1 3/4"	1 5/8"	1 1/4"	11/16"	8 5/8"
16"	21 3/16"	3 3/4"	2 1/8"	1 7/8"	1 1/2"	13/16"	10 1/8"
18"	23 15/16"	4 1/4"	2 5/16"	2 1/8"	1 7/16"	1 1/8"	11 1/4"
20"	27 1/16"	4 3/4"	2 11/16"	2 3/8"	1 3/4"	1 7/16"	13"
24"	32 1/2"	5 3/4"	3 5/16"	2 13/16"	2 1/8"	1 3/4"	15 3/4"

Attic bases are FRP.

PRO SERIES FRP SQUARE COLUMNS

Reduced size and weight - for use with Tuscan or Craftsman Cap/Base. See specifications below for net shaft widths. Shaft does NOT have molded astragal (astragal included with Tuscan cap/base sets.)

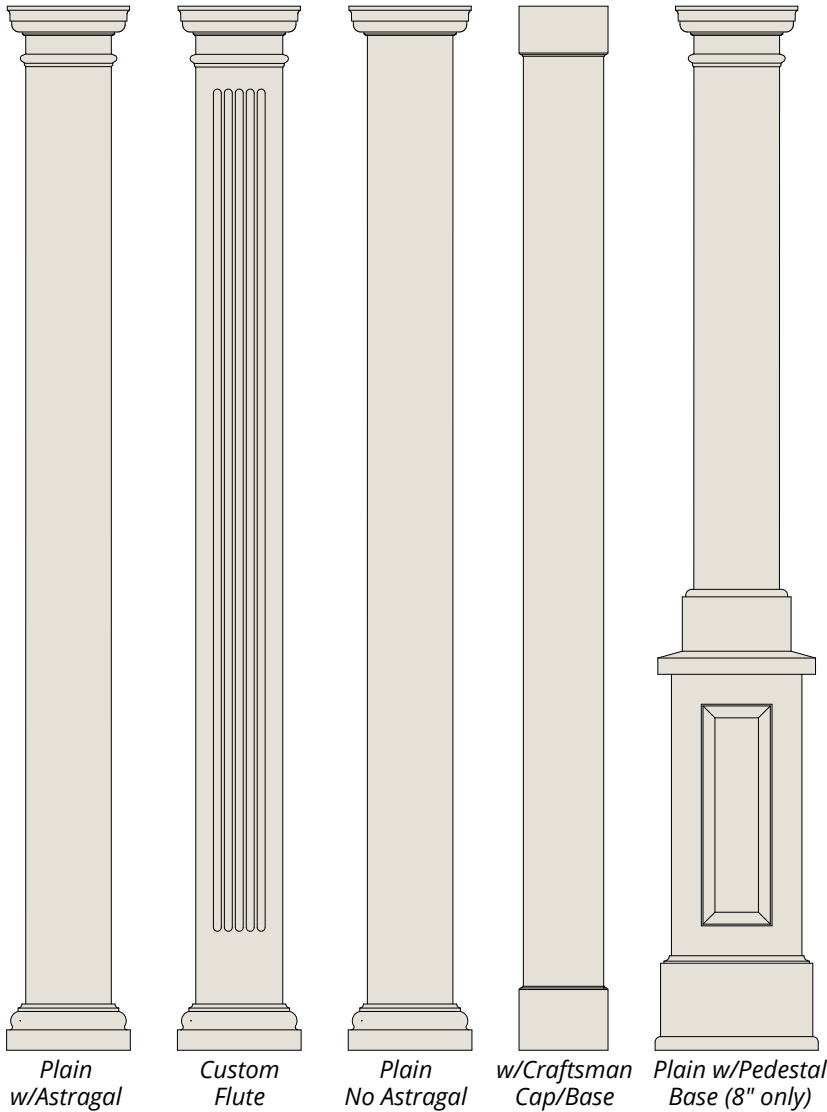

Column Nominal Width	Net Width	Inside Width (maximum)	Shaft Height	Number of Flutes	Width of Flutes	Load Bearing Capacity*
6"	5 5/8"	4 5/8"	8'	20	1/2"	6,000 lb.
			9'			
			10'			
8"	7 5/8"	6 7/8"	8'	20	11/16"	10,000 lb.
			9'			
			10'			
			12'			
10"	9 5/8"	8 7/8"	8'	20	1"	12,800 lb.
			9'			
			10'			
12"	11 3/4"	11"	10'	20	1 5/16"	18,000 lb.
			12'			
			14'			
			16'			
			18'			
14"	14"	12 3/4"	8'	20	1 1/2"	20,000 lb.
			9'			
			10'			
			12'			
			14'			

* Load capacities are reduced when loads are not centered. Full documentation online at www.turncraft.com

PRO-SERIES TUSCAN CAP AND BASE WITH ASTRAGAL MOLDING

8" and 10" cap and base sets are Timesaver (ABS), 6" & 12" cap and base sets are polyurethane.

Column Width ¹	Shaft Net Width	Tuscan Base						Tuscan Cap					
		Plinth		Torus		Height	Neck		Echinus	Abacus		Height	
		A	B	C	D	B-D	E	F ²	G	H	I	G-H	
6"	5 5/8"	7 15/16"	1 1/2"	1 1/4"	15/32"	3 7/32"	1 1/2"	1"	1 1/16"	1 1/16"	8 3/8"	2 1/8"	
8"	7 5/8"	10 9/16"	1 3/4"	1 5/8"	1/2"	3 7/8"	1 1/2"	1 3/4"	1 5/16"	1 3/8"	10 11/16"	2 11/16"	
10"	9 5/8"	13 1/2"	2 3/8"	2 1/8"	3/4"	5 1/4"	1 1/2"	1 1/2"	1 13/16"	1 3/4"	13 1/4"	3 9/16"	
12"	11 3/4"	17"	2 3/4"	2 3/8"	7/8"	6"	1 7/8"	5/8"	1 7/8"	1 7/8"	17 1/4"	3 7/8"	
14"	14"	18 13/16"	3 3/8"	2 15/16"	1 1/16"	7 3/8"	1"	2 3/16"	2 15/32"	2 11/32"	18 11/16"	4 13/16"	

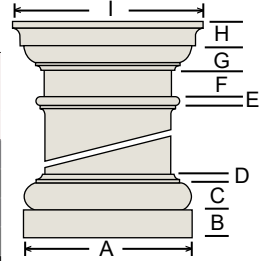

† Load capacities are reduced when loads are not centered. Full documentation online at www.turncraft.com/pdf/EccentricLoad_TCTWEB.pdf

¹ Actual outside diameters are approximately 3/8" less than shown.

² Dimension "F" shown is to match our round columns. The astragal is added during install, so the customer may place it where desired.

PRO-SERIES OPTIONAL CRAFTSMAN CAP AND BASE

No installation hardware included. Sold as sets only.

Astragal is not included. Made of PVC to match the Craftsman Series columns.

Column Width	Shaft Net Width	Craftsman Base		Craftsman Cap	
		Height	Width	Height	Width
		A	B	C	D
6"	5 5/8"	7 1/4"	6 15/16"	9 1/4"	6 15/16"
8"	7 5/8"	7 1/4"	8 15/16"	9 1/4"	8 15/16"
10"	9 5/8"	7 1/4"	10 15/16"	9 1/4"	10 15/16"
12"	11 3/4"	7 1/4"	13 1/16"	9 1/4"	13 1/16"

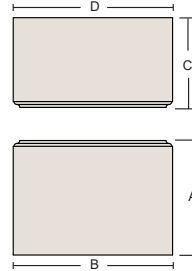

Note: 6", 8" and 10" sets are identical to Craftsman series and may be used on DuraGlass Square NT columns, Pro Series FRP, and Craftsman PVC Columns. This 12" set is custom sized and will fit only the DuraGlass and Pro Series FRP Square columns.

PRO-SERIES OPTIONAL ATTIC BASES

Column Width	Plinth		Torus				Total Height
	A	B	C	D	E	F	B-F
6"	8"	1"	3/4"	3/4"	1/2"	1/2"	3 1/2"
8"	10 7/8"	1 7/8"	1 1/8"	7/8"	3/4"	1/2"	5 1/8"
10"	13 1/4"	2 3/8"	1 1/4"	1 1/8"	7/8"	5/8"	6 1/4"
12"	16 1/8"	2 3/4"	1 1/2"	1 3/8"	1"	5/8"	7 1/4"
14"	18 1/2"	3 5/16"	1 3/4"	1 5/8"	1 1/4"	11/16"	8 5/8"

Attic bases are FRP.

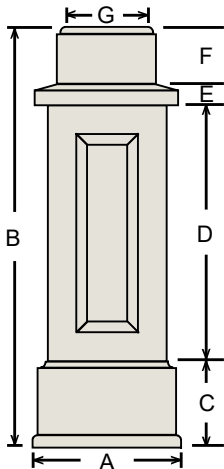
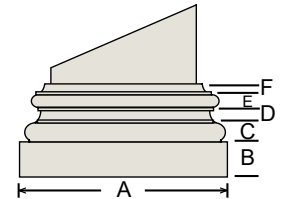

PEDESTAL BASE FOR PRO-SERIES SQUARE FRP COLUMNS

Column Width	Bottom Width	Total Height	Bottom	Center	Platform	Top	Top Width
	A	B	C	D	E	F	G
8"	15"	42 3/8"	8 11/16"	25 7/8"	2 1/8"	5 11/16"	8 1/4"

* Pedestal bases are FRP.

ORNAMENTAL CAPITALS FOR FRP PRO SERIES SQUARE COLUMNS

Many ornamental capitals are available for square no-taper columns. Please contact Turncraft for availability and pricing.



Greek Erechtheum



Roman Corinthian



Roman Ionic



Scamozzi



Temple of Winds



POLY-CLASSIC®

DGL

DuraGlass™ Columns

- EASY TO CUT AND INSTALL
- DECAY RESISTANT
- LOW MAINTENANCE
- LIGHTWEIGHT COLUMNS
- IMPACT RESISTANT
- LIMITED LIFETIME WARRANTY
- READY TO PRIME AND PAINT

LIGHTWEIGHT FIBERGLASS COLUMNS EASILY HANDLE THE LOAD

Sometimes the most beautiful solutions are the most simple. Poly-Classic® DuraGlass™ square columns from Turncraft offer the classic beauty that homeowners and commercial property owners appreciate. Made from lightweight fiberglass, these columns are easy to cut, easy to install, and strong enough to carry heavy loads. Like other Poly-Classic® columns, DuraGlass™ columns are decay resistant and require little maintenance.

PLAN TYPES

Poly-Classic® Duraglass™ Columns are available in the following plan types. Please specify when you order. (Fractional components shown are typical. Customer may specify actual returns, wall thicknesses, etc.)

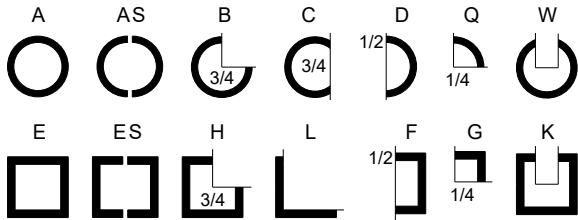

TIMESAVER FOR 8" NON-TAPERED COLUMNS

New to the Turncraft product line is our 8" square TimeSaver cap and base product. This new cap and base employs the same quick-fit installation as our round 8", 10", and 12" TimeSaver. Our TimeSaver cap and base offers the easiest and quickest installation in the industry.

Customers claim:
"The TimeSaver cap and base has cut our installation time in half."



DuraGlass™
Tuscan
Non-tapered
Square



DuraGlass™
Tuscan
Non-Tapered
Square with Neck



DuraGlass™
Bungalow
Tapered
Square

DuraGlass™
65%
lighter than standard column

DURAGLASS™ TAPERED SQUARE BUNGALOW COLUMNS

Bottom Width > Top Width x Height	Shaft Bottom		Shaft Top		Space Available Inside Shaft:		Load Capacity *
	Outside Width	Inside Width	Outside Width	Inside Width	For Round Support	For Square Support	
	(A)	(B)	(D)	(C)			
10" > 6" x 5'	9 5/8"	9"	5 5/8"	5"	4 1/2"	4 1/2"	10,000
10" > 6" x 6'							
10" > 6" x 8'							
10" > 6" x 10'							
12" > 8" x 5'	11 5/8"	11"	7 5/8"	7"	6 1/2"	6 1/2"	10,000
12" > 8" x 6'							
12" > 8" x 8'							
12" > 8" x 10'							
16" > 12" x 5'	15 5/8"	15"	11 5/8"	11"	10 1/2"	10 1/2"	10,000
16" > 12" x 6'							
16" > 12" x 8'							
16" > 12" x 10'							

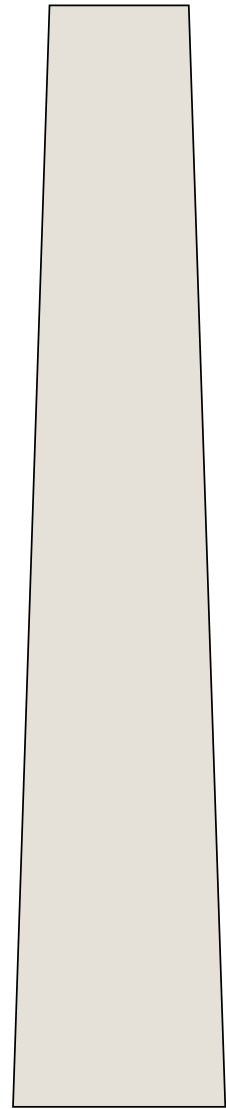
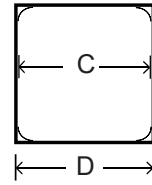

* Load capacities are reduced when loads are not centered. Split columns are not load bearing, even when re-assembled.

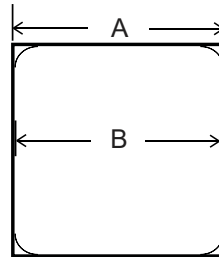

BUNGALOW CAP AND BASE SPECS

Column Nominal Width †	Column Inside Top Width (maximum)	Bungalow Base				Bungalow Cap			
		Platform		Moulding	Height	Platform		Moulding	Height
		A	B	C	B-C	D	E	F	E-F
10"	5"	13 5/8"	1"	1 1/4"	2 1/4"	9 5/8"	1"	1 1/8"	2 1/8"
12"	7"	15 5/8"	1"	1 1/4"	2 1/4"	11 5/8"	1"	1 1/8"	2 1/8"
16"	11"	19 5/8"	1"	1 1/4"	2 1/4"	15 5/8"	1"	1 1/8"	2 1/8"

† Net size is approximately 3/8" less than nominal.

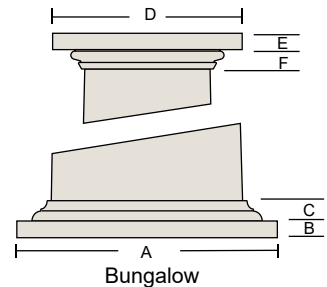

PULTRUDED TUSCAN CAP AND BASE SPECS

Column Nominal Width †	Column Inside Top Width (maximum)	Pultruded Tuscan Base					Pultruded Tuscan Cap			
		Plinth		Torus	Height	Echinus	Abacus	Height		
		A	B	C	D	B-D	F	E	D	E-F
10"	5"	13 1/8"	1 11/16"	1 5/8"	3/8"	3 11/16"	1 3/8"	1 7/16"	8 1/2"	2 13/16"
12"	7"	15 1/8"	1 11/16"	1 5/8"	3/8"	3 11/16"	1 3/8"	1 7/16"	10 1/2"	2 13/16"
16"	11"	19 1/8"	1 11/16"	1 5/8"	3/8"	3 11/16"	1 3/8"	1 7/16"	14 1/2"	2 13/16"

† Net size is approximately 3/8" less than nominal.

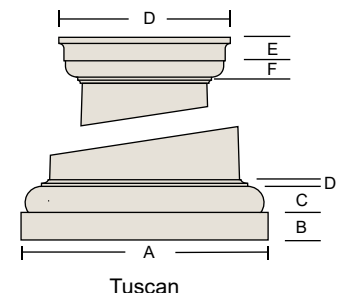

DURAGLASS™ NON-TAPERED SQUARE

Column Nominal Width †	Shaft Bottom		Shaft Top		Space Available Inside Shaft		Load Capacity lbs.
	Outside Width	Inside Width	Shaft Neck ‡	Astragal Ring	For Round Support	For Square Support	
	A	B	C	D			
8"	7 5/8"	7 1/8"	4 1/2"	3/4"	6 3/4"	6 3/4"	5,000
10"	9 5/8"	9 1/8"	5"	3/4"	8 3/4"	8 3/4"	6,000
12"	11 5/8"	11 1/8"	5 1/2"	3/4"	10 3/4"	10 3/4"	7,000
14"	14"	11 3/4"	Adjustable	1 7/8"	11 1/2"	11 1/2"	10,000
16"	16"	13 3/4"	Adjustable	1 7/8"	13 1/2"	13 1/2"	10,000
18"	18"	15 3/4"	Adjustable	1 7/8"	15 1/2"	15 1/2"	10,000
20"	20"	15 3/4"	Adjustable	1 7/8"	15 1/2"	15 1/2"	10,000

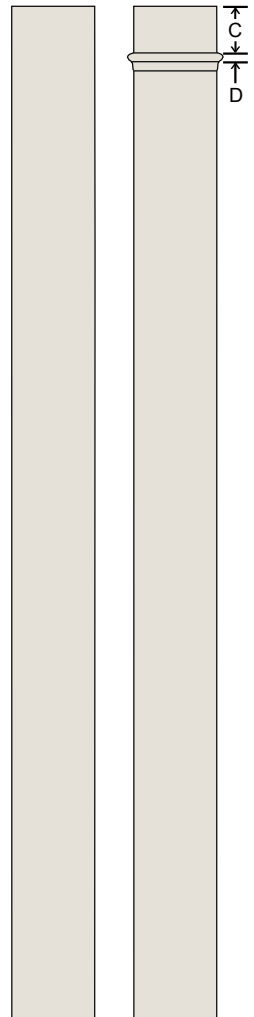
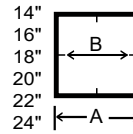
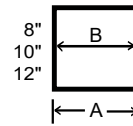

† Actual shaft net widths may vary from nominal size shown.

‡ Necking is shipped loose for pultruded columns. Spacing shown is typical, but may be adjusted by the installer.

Widths	Available Heights										
	6'	8'	9'	10'	12'	14'	16'	18'	20'	22'	24'
8"	✓	✓	✓	✓	✓						
10"	✓	✓	✓	✓	✓						
12"	✓	✓	✓	✓	✓						
14"		✓	✓	✓	✓	✓	✓	✓	✓	✓	✓
16"		✓	✓	✓	✓	✓	✓	✓	✓	✓	✓
18"		✓	✓	✓	✓	✓	✓	✓	✓	✓	✓
20"		✓	✓	✓	✓	✓	✓	✓	✓	✓	✓

The "Space Available Inside Shaft" measurements are calculated at the top inside width (with 3/8" to 3/4" tolerance), when using Tuscan caps.

When composite ornamental capitals are used, the neck sleeve will reduce the inside available space significantly.

If the column will not be required to carry a load, it may be possible for the installer to modify or remove the neck sleeve to allow more interior space. Please contact Turncraft Customer Service for more information.

These measurements are provided to assist in determining the correct column width to go around a load bearing post or lally column, or for clearance for water downspouts, conduits, etc.

TIMESAVER TUSCAN CAP AND BASE WITH NECK MOULDING

Nominal Width	Net Outside Width	Shaft Inside Width	Material	Tuscan Base					Tuscan Cap					
				Plinth		Torus		Height	Neck		Echinus	Abacus		Height
				A	B	C	D	B-D	E	F †	G	H	I	G-H
8"	7 5/8"	7 1/8"	ABS	10 9/16"	1 3/4"	1 5/8"	1/2"	3 7/8"	1 1/2"	1 3/4"	1 5/16"	1 3/8"	10 11/16"	2 11/16"
10"	9 5/8"	9 7/8"	ABS	13 1/2"	2 3/8"	2 1/8"	3/4"	5 1/4"	1 1/2"	1 1/2"	1 13/16"	1 3/4"	13 1/4"	3 9/16"

† Customer applies neck moulding. They can adjust the F dimension (necking position) as desired. Dimensions shown match the round FRP shafts.

POLYURETHANE TUSCAN CAP AND BASE WITH NECK MOULDING

Nominal Width	Net Outside Width	Shaft Inside Width	Material	Tuscan Base					Tuscan Cap					
				Plinth		Torus		Height	Neck		Echinus	Abacus		Height
				A	B	C	D	B-D	E	F †	G	H	I	G-H
8"	7 5/8"	7 1/8"	Polyurethane	11 3/8"	1 7/8"	1 3/4"	5/8"	4 1/4"	1 1/2"	1 3/4"	1 5/16"	1 3/8"	11 1/4"	2 3/4"
10"	9 5/8"	9 1/8"	Polyurethane	13 1/2"	2 3/8"	2 1/8"	3/4"	5 1/4"	1 1/2"	1 1/2"	1 13/16"	1 3/4"	13 1/4"	3 9/16"
12"	11 3/4"	11 1/4"	Polyurethane	17"	2 3/4"	2 3/8"	7/8"	6"	1 7/8"	5/8"	1 7/8"	2"	17 1/4"	3 7/8"
14"	14"	11 3/4"	Poly‡	19"	3 3/8"	2 15/16"	1"	7 5/16"	2"	2 3/16"	2 11/16"	2 5/16"	19 3/4"	5"
16"	16"	13 3/4"	Poly‡	21 7/8"	3 7/8"	3 3/8"	1 1/8"	8 3/8"	2"	2 1/4"	2 13/16"	2 3/4"	22 1/4"	5 9/16"
18"	18"	15 3/4"	Poly‡	24 5/8"	4 1/4"	3 7/8"	1 1/2"	9 5/8"	2"	2 1/4"	3"	3"	25"	6"
20"	20"	17 3/4"	Poly‡	27 3/8"	4 3/4"	4 1/4"	1 3/4"	10 3/4"	2 3/16"	2 3/4"	3 1/8"	3 3/8"	27 3/4"	6 1/2"

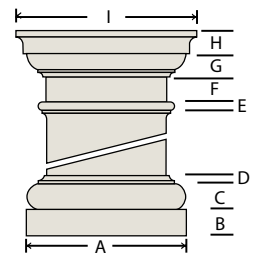

† Customer applies neck moulding. They can adjust the F dimension (necking position) as desired. Dimensions shown match the round FRP shafts.

‡ Cap, Base and Necking for 14" and larger columns ship as lineal parts, mitered, to assemble around the column.

OPTIONAL CRAFTSMAN CAP AND BASE

Column Width	Craftsman Base		Craftsman Cap	
	Height	Width (A)	Height	Width (A)
8"	9 1/4"	8 15/16"	7 1/4"	8 15/16"
10"	9 1/4"	10 15/16"	7 1/4"	10 15/16"
12"	9 1/4"	13 1/16"	7 1/4"	13 1/16"

No installation hardware included. Sold as sets only.
No necking. Made of PVC to match the Craftsman Series columns.

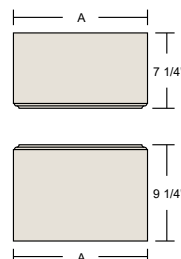



PVP *Poly-Vinyl Porch Posts*

- READY TO INSTALL
- LOW MAINTENANCE
- PROTECTIVE UV INHIBITOR
- RAIL ATTACHMENT INSERT
- SQUARE STEEL CORE
- SEAMLESS WINDOW GRADE VINYL
- READY TO PRIME AND PAINT
- LIMITED LIFETIME WARRANTY

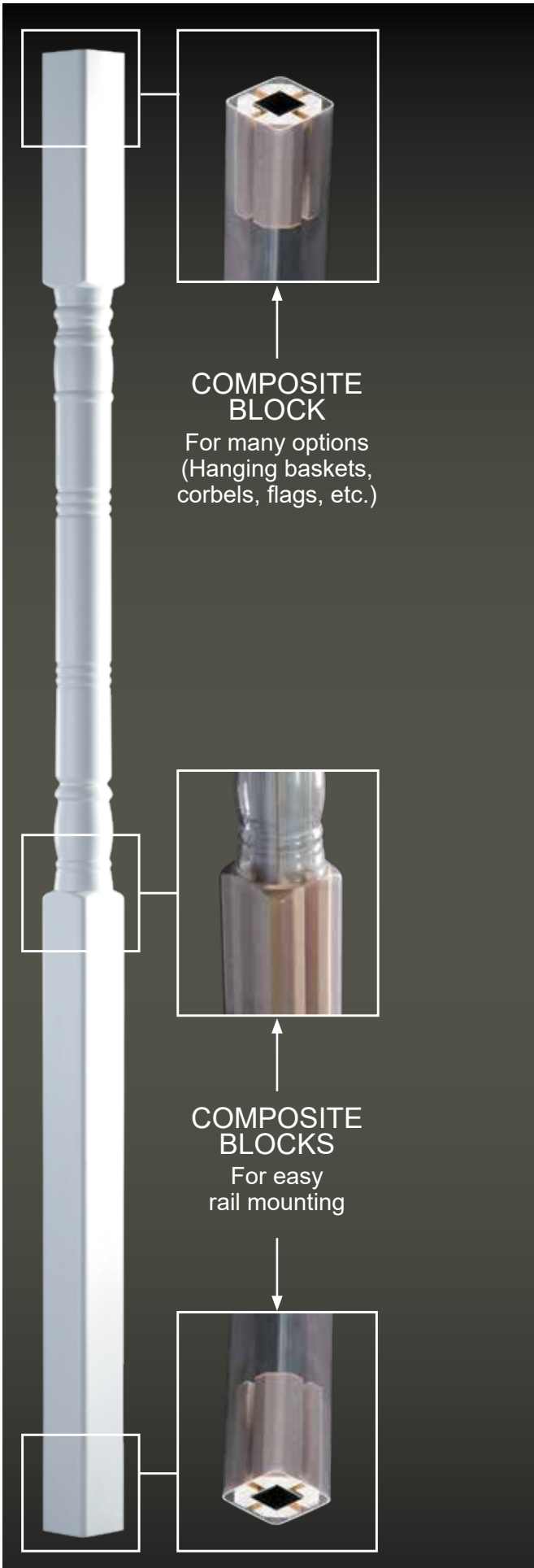

POLY-VINYL COLONIAL PORCH POSTS

Excellent design, performance, and low maintenance are built into every Turncraft Poly-Vinyl porch post. For easy rail attachment and substantial load-bearing strength, each Poly-Vinyl porch post has a galvanized steel square core and sturdy inserts at critical connection points. Constructed from seamless window grade vinyl with UV inhibitor, Poly-Vinyl porch posts are delivered with a matte white finish but can be painted to match your project. They will deliver eye-catching beauty for many years to come without the maintenance of traditional products. Installation hardware is included with the post.



Includes two standard brackets.

Larger brackets for uplift (1500 lb.) sold separately.

POLY-VINYL POSTS

Nominal Width	Actual Width	Height	Base Height	Weight	Load Bearing Capacity
5"	4 1/8"	96"	42 1/8"	23 lbs.	3,000 lbs.
5"	4 1/8"	108"	42 1/8"	27 lbs.	2,500 lbs.

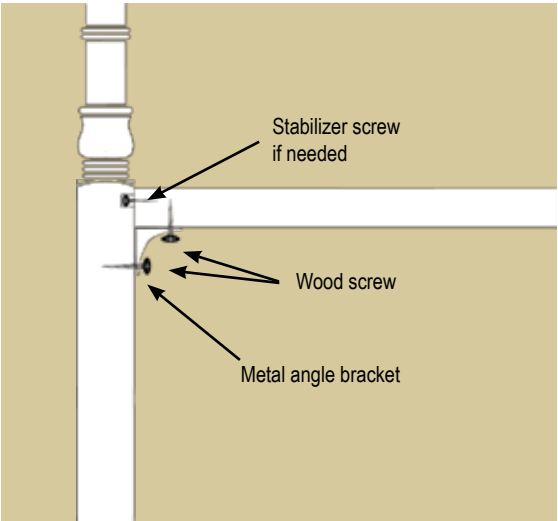



POLY-CLASSIC®

CRF *Craftsman Series*

- MADE FROM EXPANDED CELLULAR PVC
- E-Z LOCK JOINT DESIGN
- ASSEMBLES AROUND A STRUCTURAL SUPPORT
- MIX-N-MATCH
- LOW MAINTENANCE
- LIMITED LIFETIME WARRANTY
- READY TO PRIME AND PAINT
- CUSTOM SIZES AVAILABLE

**THE STYLE IS TIMELESS.
NOW THE COLUMN IS, TOO.**

Born out of the understated, practical tradition of the early 1900s Arts and Crafts movement, the square tapered column has become popular in modern adaptations of the the Craftsman, Prairie, Bungalow, Country and Mission style homes of today. Now this timeless style is available in expanded cellular PVC for quick, easy assembly and virtually maintenance-free performance!

PRECISION MITER JOINTS

Vertical edges of Craftsman shafts (tapered, non-tapered, pedestal and newel post styles) all incorporate the E-Z Lock miter joint for consistently straight miters.



PLAN TYPES

Craftsman Series are available in the following plan types. Please specify when you order. (Customer may specify actual returns, wall thicknesses, etc.) Plan O & N are available only as non-tapered.

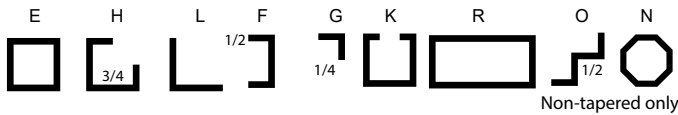

PANEL STYLES

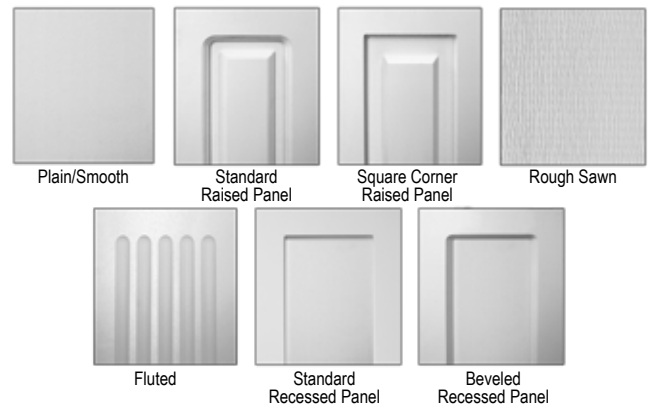

CRAFTSMAN PEDESTALS AND NEWELS



Craftsman Standard Tapered Square

Craftsman Standard Tapered Square with Raised Panels

Craftsman Standard Tapered Square with Recessed Panels

Craftsman Non-Tapered Square Smooth

Craftsman Non-Tapered Square Fluted

Craftsman Non-Tapered Square Raised Panels

Craftsman Non-Tapered Square Recessed Panels

POLY-CLASSIC® PVC CRAFTSMAN SERIES TAPERED COLUMN WRAPS

Craftsman columns are available plain, or with three different paneled options: raised panel, "square corner" raised panel, and recessed panel. (Since all tooling used for routing the panels is done with round bits, there will always be some radius in the corners. The "square corner" style uses the smallest bit possible to minimize that radius - about 1/16".)

Bottom Width* > Top Width* x Height (A)	Shaft dimensions				Panel dimensions †			
	Bottom		Top		From bottom of shaft ‡	From top of shaft	From side of shaft	Width of routed channel
	Outside width	Inside width	Outside width	Inside width				
	B	C	E	D	F	G	I	H
10" > 6" x 4'	9 5/8"	8 3/8"	5 5/8"	4 3/8"	10 1/2"	2 1/2"	1 1/4"	1/4"
10" > 6" x 5'								
10" > 6" x 6'								
10" > 6" x 8'								
10" > 6" x 9'								
10" > 6" x 10'								
12" > 6" x 4'	11 5/8"	10 3/8"	7 5/8"	6 3/8"	10 1/2"	2 1/2"	1 1/2"	1 1/4"
12" > 6" x 5'								
12" > 6" x 6'								
12" > 6" x 8'								
12" > 6" x 9'								
12" > 6" x 10'								
16" > 6" x 4'	15 5/8"	14 3/8"	11 5/8"	10 3/8"	10 1/2"	2 1/2"	1 1/2"	1 1/4"
16" > 6" x 5'								
16" > 6" x 6'								
16" > 6" x 8'								
16" > 6" x 9'								
16" > 6" x 10'								
20" > 6" x 4'	19 5/8"	18 3/8"	13 5/8"	12 3/8"	10 1/2"	2 1/2"	1 1/2"	1 1/4"
20" > 6" x 5'								
20" > 6" x 6'								
20" > 6" x 8'								
20" > 6" x 9'								
20" > 6" x 10'								
24" > 6" x 4'	23 5/8"	22 3/8"	15 5/8"	14 3/8"	10 1/2"	2 1/2"	1 1/2"	1 1/4"
24" > 6" x 5'								
24" > 6" x 6'								
24" > 6" x 8'								
24" > 6" x 9'								
24" > 6" x 10'								

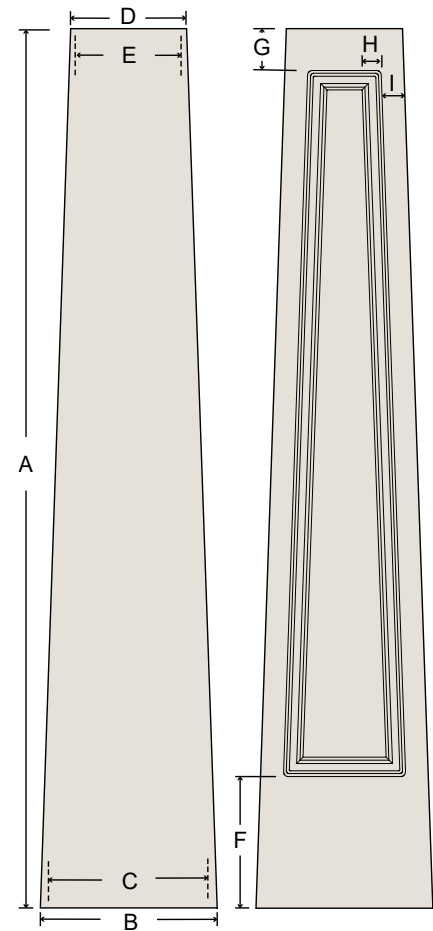

* Actual net width is 3/8" less than nominal (before trimming). Standard cap and base add 5" to the net width.
Corners on our "Square Corner" Raised Panel are as close to square as can be cut with the CNC router - approx 1/16" radius.

POLY-CLASSIC® PVC CRAFTSMAN SERIES TAPERED CAP AND BASE

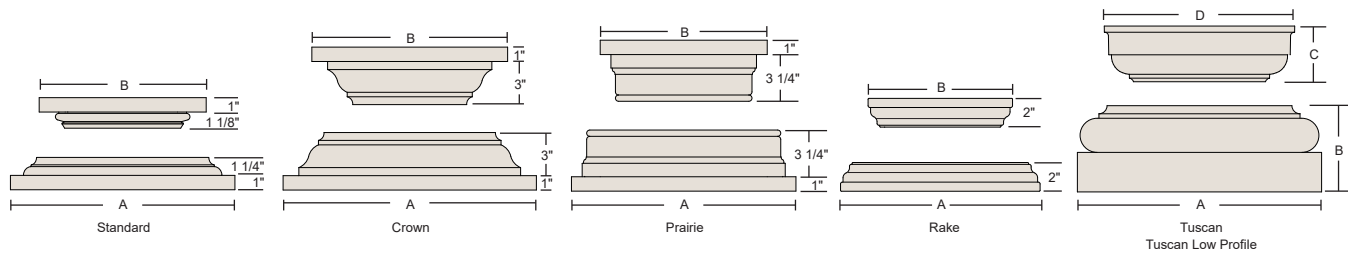

Column nominal bottom width	Standard		Crown		Prairie		Rake		Tuscan *				Tuscan Low Profile **			
	Base	Cap	Base	Cap	Base	Cap	Base	Cap	Base		Cap		Base		Cap	
	A	B	A	B	A	B	A	B	A	B	C	D	A	B	C	D
10"	13 5/8"	9 5/8"	15 5/8"	11 5/8"	13 5/8"	9 5/8"	12"	8"	13 1/2"	5 1/4"	9 1/2"	3 9/16"	n/a			
12"	15 5/8"	11 5/8"	17 5/8"	13 5/8"	15 5/8"	11 5/8"	14"	10"	17"	6"	13"	3 7/8"	n/a			
16"	19 5/8"	15 5/8"	21 5/8"	17 5/8"	19 5/8"	15 5/8"	18"	14"	19 1/2"	8 3/8"	18 3/8"	5 9/16"	20 5/8"	7 7/16"	17 3/4"	5"
20"	23 5/8"	17 5/8"	25 5/8"	19 5/8"	23 5/8"	17 5/8"	22"	16"	27"	10 3/4"	22 1/4"	6 1/2"	24 5/8"	7 7/16"	20 1/4"	5"
24"	27 5/8"	19 5/8"	29 5/8"	21 5/8"	27 5/8"	19 5/8"	26"	18"	32 1/2"	13 1/4"	26 1/4"	7 13/16"	28 5/8"	7 7/16"	22 3/8"	5"

* 10" and 12" cap/base are "L" shape mitered parts; 14" and larger are shipped in lineal parts, mitered to fit.

** This cap and base set uses the 14" Tuscan cap and base profile, for all widths, with standard necking. These are the style of Tuscan cap and base used on PVC prior to 2021, and are suitable for replacements to match those, as well as new projects.

POLY-CLASSIC® CRAFTSMAN NON-TAPERED SQUARE

Nominal Width	Shaft Dimensions		Panel and Flute Spacing †		Panels †		Flutes	
	Net Bottom Width	Inside Bottom Width	From bottom of Shaft ‡	From Top of Shaft	From Side of Shaft	Width of Routed Channel	Number of Flutes	Flute Width
	B	C	D	E	G	F		
6"	5 5/8"	4 3/8"	16 3/4"	8 1/2"	1 1/4"	3/4"	20	1/2"
8"	7 5/8"	6 3/8"	16 3/4"	8 1/2"	1 1/2"	1 1/4"	20	3/4"
10"	9 5/8"	8 3/8"	16 3/4"	8 1/2"	1 1/2"	1 1/4"	20	1"
12"	11 5/8"	10 3/8"	16 3/4"	8 1/2"	1 1/2"	1 1/4"	20	1 1/4"
14"	13 5/8"	12 3/8"	16 3/4"	9"	2"	1 1/4"	24	1 1/4"
16"	15 5/8"	14 3/8"	16 3/4"	9 1/4"	2 1/4"	1 1/4"	28	1 1/4"
18"	17 5/8"	16 3/8"	16 3/4"	9 1/2"	2 1/2"	1 1/4"	32	1 1/4"
20"	19 5/8"	18 3/8"	16 3/4"	9 3/4"	2 3/4"	1 1/4"	36	1 1/4"
22"	21 5/8"	20 3/8"	16 3/4"	10"	3"	1 1/4"	40	1 1/4"
24"	23 5/8"	22 3/8"	16 3/4"	10 1/4"	3 1/4"	1 1/4"	44	1 1/4"

† Dimensions except width also apply to recessed panel shafts.

‡ Dimension shown is for standard shafts. On custom height columns the panels/flutes start 4" from the top of the base selected, and dimension (G) from the cap (or optional neck moulding).

Nominal Column Width	Standard Sizes A							Nominal Column Width	Standard Sizes A								
	4'	5'	6'	8'	9'	10'	12'		8'	10'	12'	14'	16'	18'	20'	22'	24'
6"	✓	✓	✓	✓	✓	✓	✓	14"	✓	✓	✓	✓					
8"	✓	✓	✓	✓	✓	✓	✓	16"	✓	✓	✓	✓	✓				
10"	✓	✓	✓	✓	✓	✓	✓	18"	✓	✓	✓	✓	✓	✓			
12"	✓	✓	✓	✓	✓	✓	✓	20"	✓	✓	✓	✓	✓	✓	✓		
								22"	✓	✓	✓	✓	✓	✓	✓	✓	
								24"	✓	✓	✓	✓	✓	✓	✓	✓	✓

Custom widths and heights may be requested in any size up to 24' tall and 48" wide. Cap and base trim and platforms will be adjusted as needed for the revised shaft width.

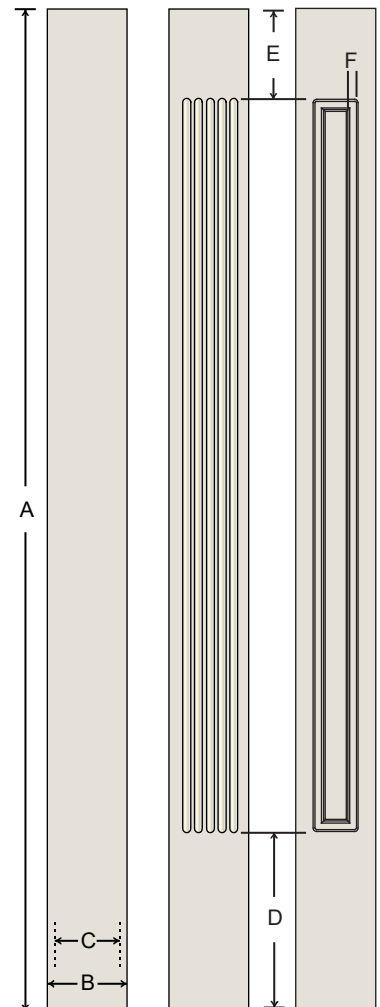

POLY-CLASSIC® PVC CRAFTSMAN SERIES NON-TAPERED CAP AND BASE

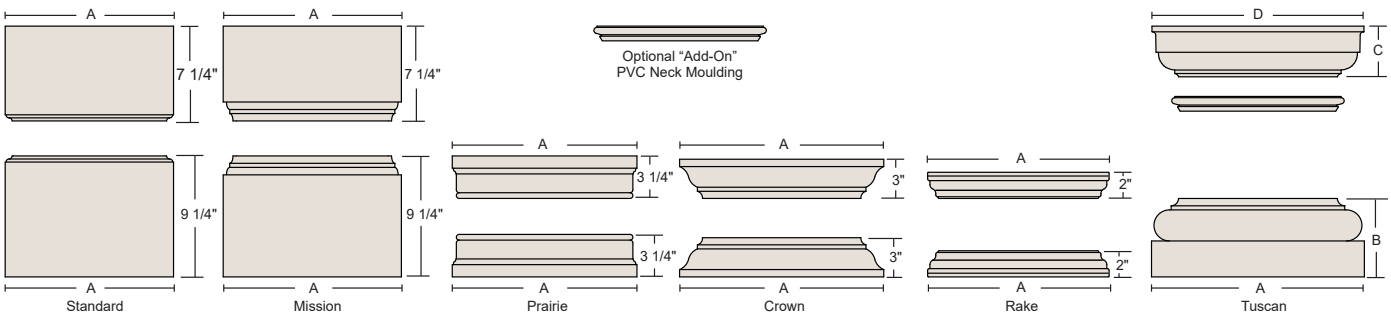

Column Width	Standard Width A	Mission Width A	Prairie Width A	Crown Width A	Rake Width A	Tuscan *				Tuscan Low Profile **			
						Base		Cap		Base		Cap	
						Width A	Height B	Width C	Height D	Width A	Height B	Width C	Height D
6"	6 7/8"	7 5/8"	8 1/8"	9 7/8"	8"	8"	3 7/32"	8 7/16"	2 1/2"	n/a			
8"	8 7/8"	9 5/8"	10 1/8"	11 7/8"	10"	11 3/8"	4 1/4"	11 1/4"	2 11/16"	n/a			
10"	10 7/8"	11 5/8"	12 1/8"	13 7/8"	12"	13 1/2"	5 1/4"	13 7/32"	3 9/16"	n/a			
12"	12 7/8"	13 5/8"	14 1/8"	15 7/8"	14"	17"	6"	17 1/4"	3 7/8"	n/a			
14"	14 7/8"	15 5/8"	16 1/8"	17 7/8"	16"	18 5/8"	7 7/16"	19"	5"	18 5/8"	7 7/16"	19"	5"
16"	16 7/8"	17 5/8"	18 1/8"	19 7/8"	18"	21 1/2"	8 3/8"	21 7/8"	5 9/16"	20 5/8"	7 7/16"	21"	5"
18"	18 7/8"	19 5/8"	20 1/8"	21 7/8"	20"	24 1/4"	9 5/8"	24 5/8"	6"	22 5/8"	7 7/16"	23"	5"
20"	20 7/8"	21 5/8"	22 1/8"	23 7/8"	22"	27"	10 3/4"	27 3/8"	6 1/2"	24 5/8"	7 7/16"	25"	5"
22"	22 7/8"	23 5/8"	24 1/8"	25 7/8"	24"	29 3/4"	12 1/8"	30 1/8"	7 3/16"	26 5/8"	7 7/16"	27"	5"
24"	24 7/8"	25 5/8"	26 1/8"	27 7/8"	26"	32 1/2"	13 1/4"	32 7/8"	7 13/16"	28 5/8"	7 7/16"	27"	5"

* 6" to 12" cap/base are "L" shape mitered parts; 14" and larger are shipped in lineal parts, mitered to fit.

** This cap and base set uses the 14" Tuscan cap and base profile, for all widths, with standard necking. These are the style of Tuscan cap and base used on PVC prior to 2021, and are suitable for replacements to match those, as well as new projects.

POLY-CLASSIC® PVC CRAFTSMAN SERIES ROUGH-SAWN COLUMNS

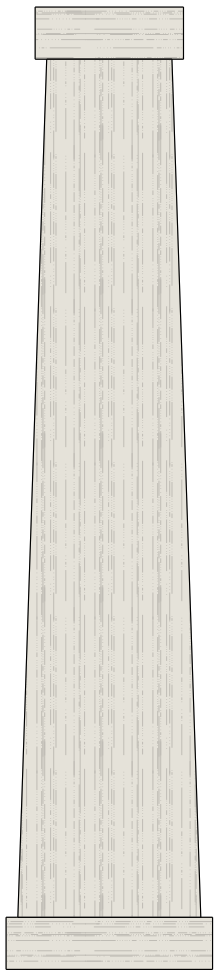

Bottom Width* > Top Width* > x Height (A)	Shaft dimensions			
	Bottom		Top	
	Outside width	Inside width	Outside width	Inside width
	B	C	E	D
10" > 6" x 4'	9 5/8"	8 3/8"	5 5/8"	4 3/8"
10" > 6" x 5'				
10" > 6" x 6'				
10" > 6" x 8'				
10" > 6" x 9'				
10" > 6" x 10'				
12" > 6" x 4'	11 5/8"	10 3/8"	7 5/8"	6 3/8"
12" > 6" x 5'				
12" > 6" x 6'				
12" > 6" x 8'				
12" > 6" x 9'				
12" > 6" x 10'				



The Craftsman Series Rough-Sawn columns come in tapered and non-tapered styles.

- * Limited Lifetime Warranty
- * Shipped KD (knockdown) and palletized.
- * E-Z Lock joints for easy installation.
- * Precision milled expanded cellular PVC
- * Low maintenance, rot proof, water proof, insect proof

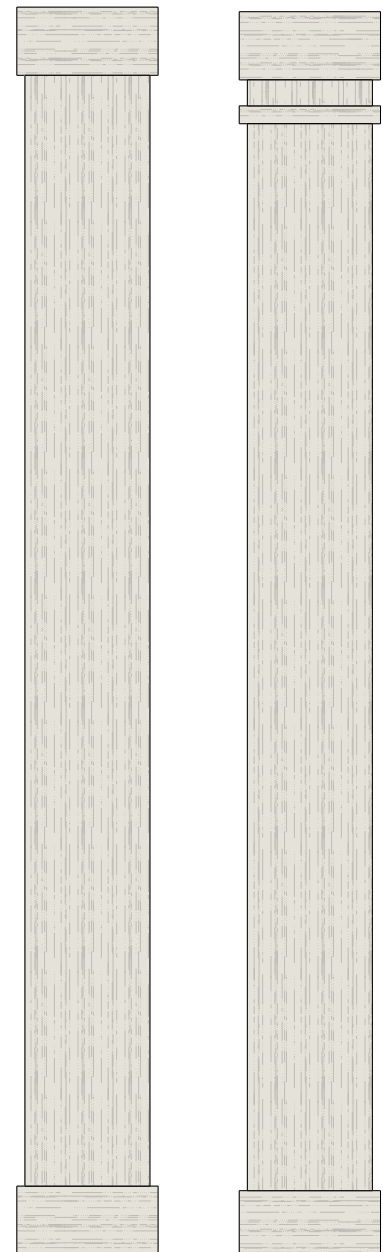

TAPERED CAP AND BASE



Column Width	Width	Height
10"	10 7/8"	3 1/4"
12"	12 7/8"	3 1/4"

NON-TAPERED CAP AND BASE



Column Width	Width	Height
6"	6 7/8"	5 1/4"
8"	8 7/8"	5 1/4"
10"	10 7/8"	5 1/4"
12"	12 7/8"	5 1/4"

Nominal Width* x Height	Shaft dimensions	
	Bottom	
	Outside width	Inside width
	B	C
6" x 4'	5 5/8"	4 3/8"
6" x 5'		
6" x 6'		
6" x 8'		
6" x 9'		
6" x 10'		
6" x 12'	7 5/8"	6 3/8"
8" x 4'		
8" x 5'		
8" x 6'		
8" x 8'		
8" x 9'		
8" x 10'	9 5/8"	8 3/8"
8" x 12'		
10" x 4'		
10" x 5'		
10" x 6'		
10" x 8'		
10" x 9'	11 5/8"	10 3/8"
10" x 10'		
10" x 12'		
12" x 4'		
12" x 5'		
12" x 6'		
12" x 8'		
12" x 9'		
12" x 10'		
12" x 12'		

* Actual net width is 3/8" less than nominal. Standard cap and base add 1-1/4" to the net width.

POLY-CLASSIC® CRAFTSMAN PEDESTALS AND NEWELS



Standard Pedestal



Prairie Pedestal Recessed Panel



Prairie Pedestal Raised Panel

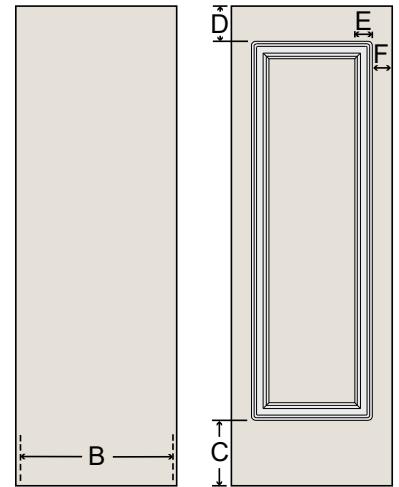

Nominal Width	Shaft Widths		Panels (Standard Trim)		Panels (Prairie Trim)		Panels		Available Heights						
	Outside B	Inside C	From Bottom of Shaft D	From Top of Shaft E	From Bottom of Shaft D	From Top of Shaft E	Width of Router Channel F	From Side of Shaft G	32"	36"	40"	44"	48"	54"	60"
									✓	✓	✓	✓	✓	✓	✓
6"	5 5/8"	4 3/8"	4 3/4"	3 3/4"	4 3/4"	2 5/8"	7/8"	1 1/4"	✓	✓	✓	✓	✓	✓	✓
8"	7 5/8"	6 3/8"	4 3/4"	3 3/4"	4 3/4"	2 5/8"	1 1/4"	1 1/2"	✓	✓	✓	✓	✓	✓	✓
10"	9 5/8"	8 3/8"	4 3/4"	3 3/4"	4 3/4"	2 5/8"	1 1/4"	1 1/2"	✓	✓	✓	✓	✓	✓	✓
12"	11 5/8"	10 3/8"	4 3/4"	3 3/4"	4 3/4"	2 5/8"	1 1/4"	1 1/2"	✓	✓	✓	✓	✓	✓	✓
14"	13 5/8"	12 3/8"	5 1/4"	4 1/4"	5 1/4"	3 1/8"	1 1/4"	2"	✓	✓	✓	✓	✓	✓	✓
16"	15 5/8"	14 3/8"	5 1/2"	4 1/2"	5 1/2"	3 3/8"	1 1/4"	2 1/4"	✓	✓	✓	✓	✓	✓	✓
18"	17 5/8"	16 3/8"	5 3/4"	4 3/4"	5 3/4"	3 5/8"	1 1/4"	2 1/2"	✓	✓	✓	✓	✓	✓	✓
20"	19 5/8"	18 3/8"	6"	5"	6"	3 7/8"	1 1/4"	2 3/4"	✓	✓	✓	✓	✓	✓	✓
22"	21 5/8"	20 3/8"	6 1/4"	5 1/4"	6 1/4"	4 1/8"	1 1/4"	3"	✓	✓	✓	✓	✓	✓	✓
24"	23 5/8"	22 3/8"	6 1/2"	5 1/2"	6 1/2"	4 3/8"	1 1/4"	3 1/4"	✓	✓	✓	✓	✓	✓	✓
26"	25 5/8"	24 3/8"	6 3/4"	5 3/4"	6 3/4"	4 5/8"	1 1/4"	3 1/2"	✓	✓	✓	✓	✓	✓	✓
28"	27 5/8"	26 3/8"	7"	6"	7"	4 7/8"	1 1/4"	3 3/4"	✓	✓	✓	✓	✓	✓	✓
30"	29 5/8"	28 3/8"	7 1/4"	6 1/4"	7 1/4"	5 1/8"	1 1/4"	4"	✓	✓	✓	✓	✓	✓	✓

* Typically, pedestals are 4" wider than the column it is supporting, or about the same width as the base of the column which it supports.

POLY-CLASSIC® CRAFTSMAN PEDESTALS AND NEWEL CAPS AND BASES

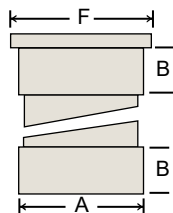

Standard Trim

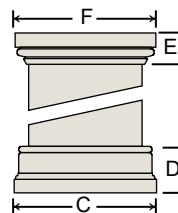

Prairie Trim

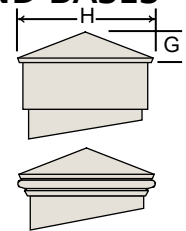

Pyramid Cap

Column Nominal Width	Standard Trim		Prairie Trim				Pyramid Cap	
	Width (A)	Height (B)	Width (C)	Height (D)	Top Height (E)	Top Width † (F)	Height± 1/16" (G)	Width (H)
6"	6 7/8"	3 1/4"	8 1/8"	3 1/4"	2 1/8"	7 5/8"	2 1/16"	7 7/8"
8"	8 7/8"	3 1/4"	10 1/8"	3 1/4"	2 1/8"	9 5/8"	2 1/2"	9 7/8"
10"	10 7/8"	3 1/4"	12 1/8"	3 1/4"	2 1/8"	11 5/8"	2 7/8"	11 7/8"
12"	12 7/8"	3 1/4"	14 1/8"	3 1/4"	2 1/8"	13 5/8"	3 1/4"	13 7/8"
14"	14 7/8"	3 1/4"	16 1/8"	3 1/4"	2 1/8"	15 5/8"	3 5/8"	15 7/8"
16"	16 7/8"	3 1/4"	18 1/8"	3 1/4"	2 1/8"	17 3/8"	4"	17 7/8"
18"	18 7/8"	3 1/4"	20 1/8"	3 1/4"	2 1/8"	19 5/8"	4 3/8"	19 7/8"
20"	20 7/8"	3 1/4"	22 1/8"	3 1/4"	2 1/8"	21 5/8"	4 13/16"	21 7/8"
22"	22 7/8"	3 1/4"	24 1/8"	3 1/4"	2 1/8"	23 5/8"	5 3/16"	23 7/8"
24"	24 7/8"	3 1/4"	26 1/8"	3 1/4"	2 1/8"	25 5/8"	5 9/16"	25 7/8"
26"	26 7/8"	3 1/4"	28 1/8"	3 1/4"	2 1/8"	27 5/8"	6 5/16"	27 7/8"
28"	28 7/8"	3 1/4"	30 1/8"	3 1/4"	2 1/8"	29 5/8"	6 3/8"	29 7/8"
30"	30 7/8"	3 1/4"	32 1/8"	3 1/4"	2 1/8"	31 5/8"	6 3/4"	31 7/8"

POLY-CLASSIC® CRAFTSMAN ORNAMENTAL CAPITALS

Designed with crisp, true architectural detail, Ornamental Capitals artfully capture natural themes and images. Capitals for square Non-tapered Poly-Classic® Craftsman columns are crafted from poly/resin, and will ship split in half (to reassemble around the load support). Each style is proportionally scaled for the width of the shaft. The Empire with Necking, Greek

Erectheum with Necking, Modern Composite, Roman Corinthian, Roman Doric Ornamental, and Temple of Winds capitals will fit more accurately when the optional neck moulding is included. Since the shafts will be manufactured to be correct with the selected capital, there is no need to worry about a height adjustment value with PVC columns. Larger sizes may be available.



Empire



Empire with Necking



Greek Angular Ionic



Greek Erectheum



Greek Erectheum with Necking



Modern Composite



Roman Corinthian



Roman Doric Ornamental



Roman Ionic



Scamozzi



Temple of Winds

Shaft nominal bottom diameter	Empire			Empire with necking			Greek Angular Ionic			Greek Erectheum			Greek Erectheum with necking			Modern Composite		
	Capital height	Abacus width	Scroll width	Capital height	Abacus width	Scroll width	Capital height	Abacus width	Scroll width	Capital height	Abacus width	Scroll width	Capital height	Abacus width	Scroll width	Capital height	Abacus width	Scroll width
6"	3 3/4"	10"	9"	7 3/4"	10"	9"	n/a			3 3/4"	7 3/4"	11 3/4"	5 3/4"	7 3/4"	11 3/4"	8 1/2"	10 3/4"	n/a
8"	5 1/4"	13 1/2"	12 1/4"	10"	13 1/2"	12 1/4"	5 1/8"	14 1/4"	13 3/4"	5 1/4"	10 1/2"	15"	7 1/2"	10 1/2"	15"	11 1/2"	16 1/2"	n/a
10"	6 1/4"	18"	17"	11"	18"	17"	6"	17 1/4"	17"	6 1/4"	14 1/2"	21"	9 1/2"	14 1/2"	21"	14 1/2"	19"	n/a
12"	7 1/4"	20 1/4"	19 1/2"	14 1/2"	20 1/2"	19 1/2"	7 1/4"	20 3/4"	19 1/4"	6 3/4"	15"	20 1/2"	11 1/4"	15"	21"	17"	20"	n/a
14"	8 3/4"	23"	19 1/2"	17"	23"	19 1/2"	8 3/8"	20 1/2"	19 1/2"	9"	17 1/2"	26"	13 1/2"	17 1/2"	26"	n/a		
16"	10"	32"	26 1/4"	n/a			9 3/4"	24 1/4"	19 3/4"	10"	22 1/2"	29"	15"	22 1/2"	29"	22 1/2"	25"	n/a
18"	11 1/4"	34"	28"	n/a			n/a			11"	26"	36"	17"	26"	36"	n/a		
20"	12 3/4"	35 1/2"	35"	19"	35 1/2"	35"	12 3/4"	35"	34 1/2"	13"	30 1/2"	43"	19"	30 1/2"	43"	n/a		

Shaft nominal bottom diameter	Roman Corinthian			Roman Doric Ornamental			Roman Ionic			Scamozzi			Temple of Winds		
	Capital height	Abacus width	Scroll width	Capital height	Abacus width	Scroll width	Capital height	Abacus width	Scroll width	Capital height	Abacus width	Scroll width	Capital height	Abacus width	Scroll width
6"	8 1/2"	12"	n/a	4 1/2"	10 1/2"	n/a	3"	8 1/4"	10 1/2"	2 7/8"	10"	8"	7 1/2"	10 1/2"	n/a
8"	12"	15"	n/a	6"	14 1/4"	n/a	3 5/8"	10 1/2"	13 1/2"	3 1/2"	11"	9 3/8"	10"	13 7/8"	n/a
10"	14 1/2"	18 1/2"	n/a	7"	16 1/4"	n/a	4 1/2"	12 1/2"	16 1/2"	4 7/8"	16 3/4"	14"	11 5/8"	16 7/8"	n/a
12"	17"	22"	n/a	9"	21"	n/a	5 1/2"	17 1/2"	23"	5 1/2"	19"	16 3/4"	16"	19"	n/a
14"	20"	27"	n/a	10 1/2"	24"	n/a	6 1/8"	17 1/2"	22"	6 1/4"	22 1/4"	18 1/2"	16"	23"	n/a
16"	23"	32 1/2"	n/a	12 1/2"	28"	n/a	6 1/2"	20"	24 1/4"	7 1/2"	25"	20 1/4"	18 1/8"	26 3/4"	n/a
18"	25 1/2"	39"	n/a	n/a			8 3/4"	25"	31 3/4"	8 3/4"	26"	21 1/2"	21 1/2"	28"	n/a
20"	28 1/2"	42"	n/a	n/a			9"	25 1/4"	33"	10 1/4"	34 1/4"	29 1/2"	23 1/4"	34 1/2"	n/a

MIX-N-MATCH

CRAFTSMAN SERIES PEDESTALS WITH POLY-CLASSIC® FRP COLUMNS

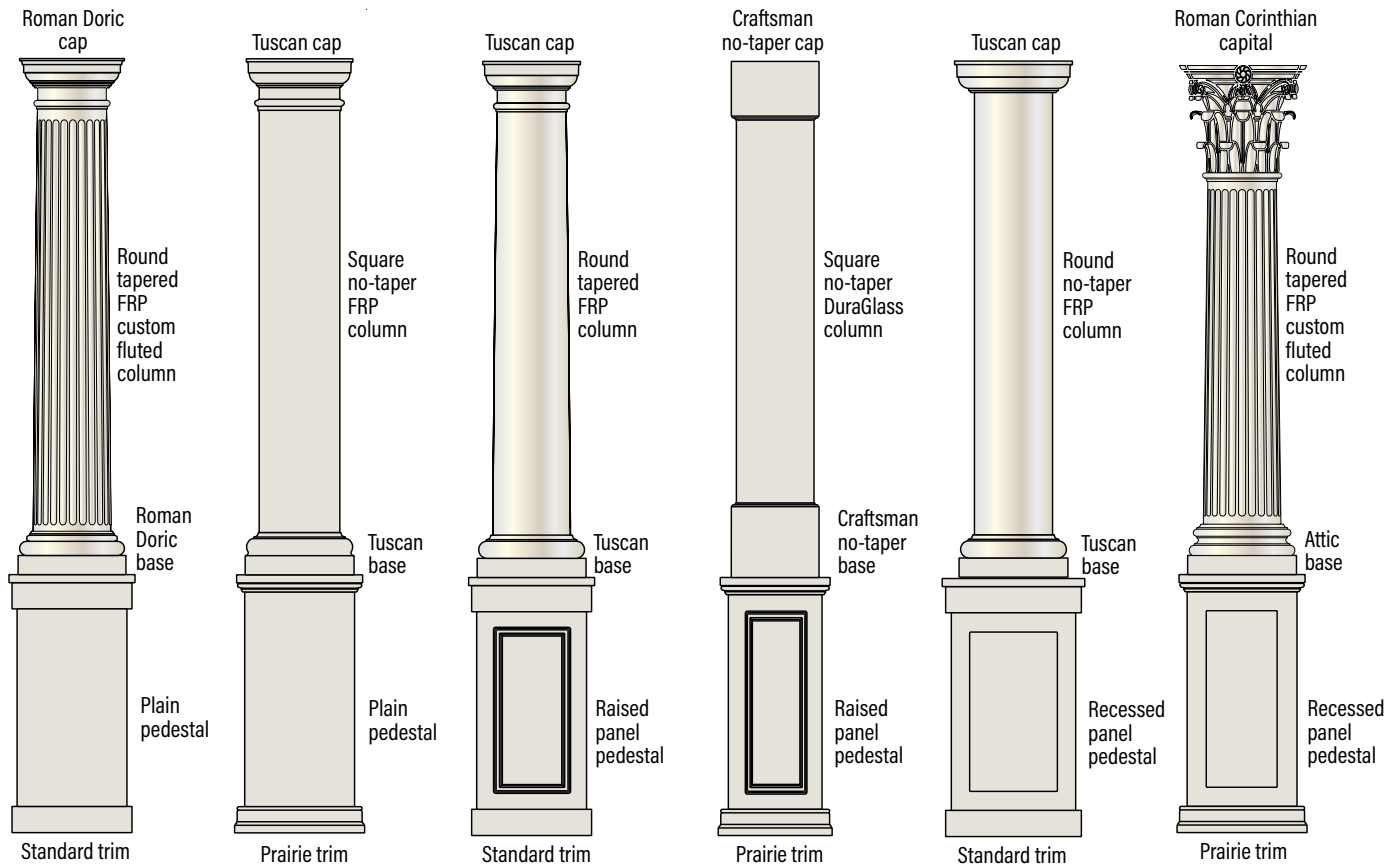

MIX-N-MATCH

CRAFTSMAN SERIES COLUMNS WITH CRAFTSMAN SERIES PEDESTALS

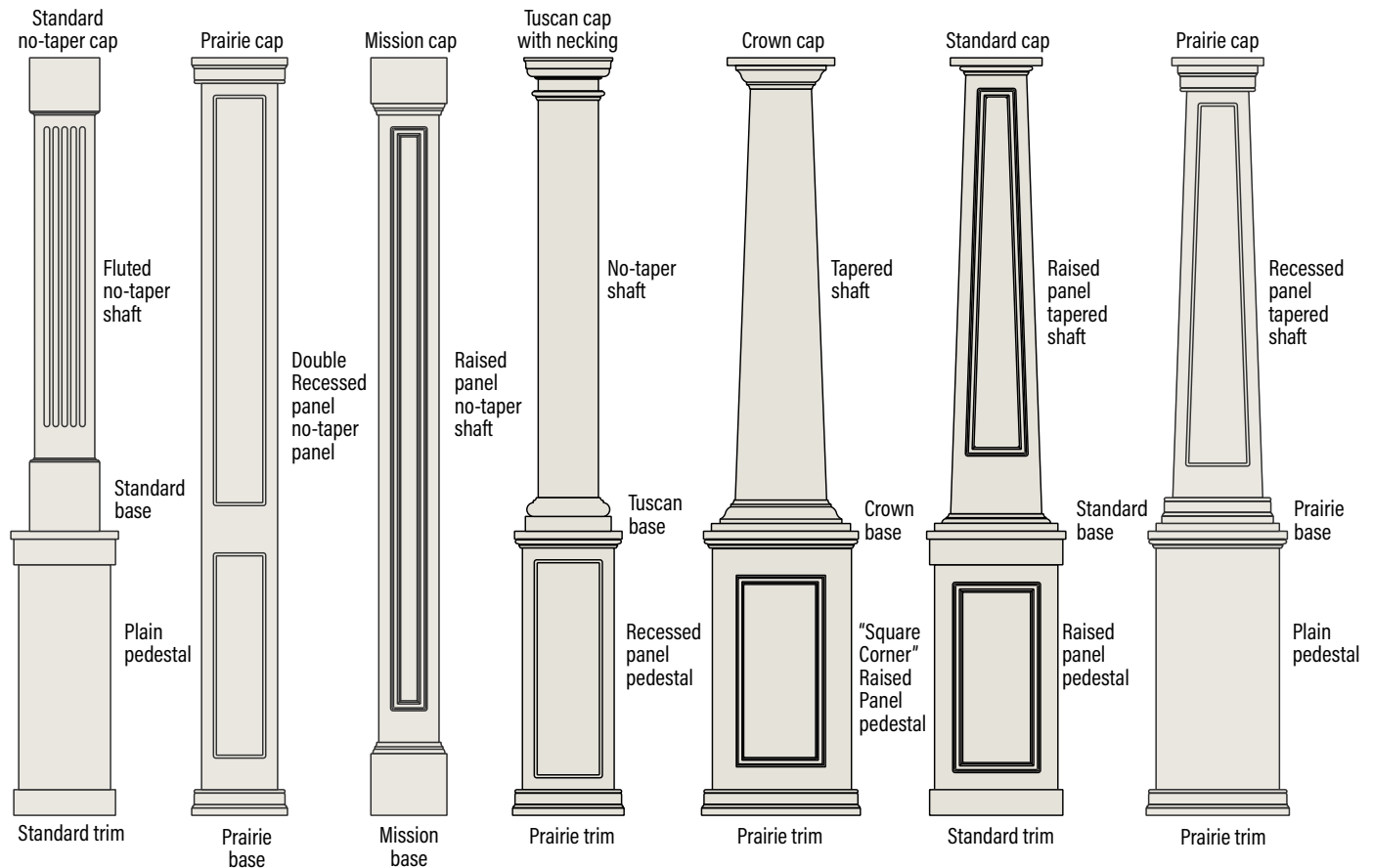



TURNCRAFT

ARC

Architectural Series

- ARCHITECTURALLY CORRECT DETAILS
- ALL ORDERS OF CLASSICAL COLUMNS
- CORRECT PROPORTIONS OR CUSTOM DESIGNS
- INTERIOR AND EXTERIOR
- WIDEST RANGE OF STYLES AND SIZES
- ANY WOOD SPECIES
- FACTORY OPTIONS INCLUDE PRIMING AND ASPHALT COATING
- CEDAR COLUMNS HAVE A 10 YEAR LIMITED WARRANTY

Comparison of the Orders

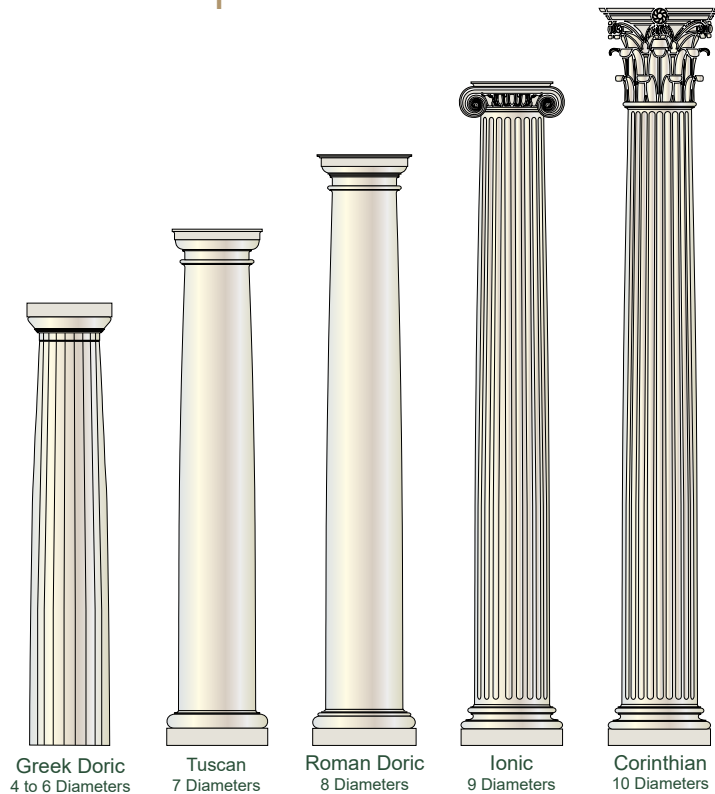

Turncraft Architectural wood columns are our premier product for precise attention to detail both in design and quality. Unlike FRP columns, where the manufacturing processes dictate some alterations to details, our wood columns are closest to true architectural specifications such as proportion, fluting and entasis (taper or bow).

Architectural columns are best proportioned when following the suggestions of William Ware (*The American Vignola*), Robert Chitham (*The Classic Orders of Architecture*), Palladio and others to emulate the ancient architecture of Greece and Rome. The illustration "Comparison of the Orders" shows how the height and diameter ratio affects columns of a similar diameter. Tip: to determine the correct diameter for a column in the height you need, simply divide the height by the diameter factor given below the style chosen. For example, at a two-story height of 198", an Ionic column (9 diameters) should be 22" in diameter ($198/9=22$), or a Tuscan column (7 diameters) should be 28" in

diameter.

In addition to the round columns shown, Turncraft Architectural can provide wood columns in non-architectural proportions, in many plan types, including squares, octagons and pilasters, either straight or tapered, as well as coupled columns, and other custom configurations.

Using our computerized lathes, our wood columns typically have the correct column entasis (taper or bow) – the lower one-third of the shaft is straight, and the upper two-thirds has a diminishing taper. The "Entasis Taper" illustration shows precisely how this is generated. We also have the ability to customize the shaft taper. For example, straight tapers are common, as well as barrel columns where the center of the shaft is larger than both ends.

For exterior use, the recommended wood for shafts is cedar because of its inherent resistance to insects and wood rot, and carries a ten year limited warranty. Pine is also available, with a one year limited warranty. Cap and base for exterior columns are usually polyurethane (up to 16" columns) or fiberglass (18" and larger).

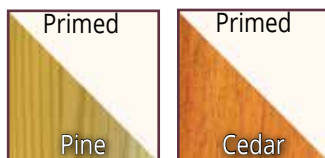

For interior use, Turncraft is able to manufacture columns from a wide variety of woods. Paint grade woods are typically finger-jointed pine or poplar, and stain grade can be practically any species imaginable.

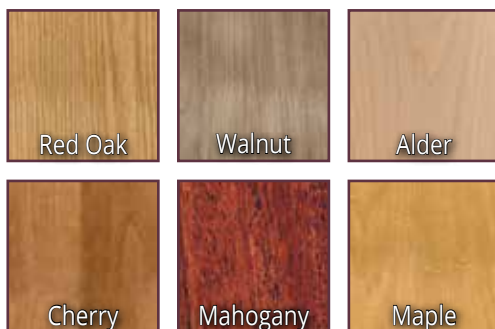

Our most popular stain grade species are red oak, mahogany, cherry, maple, alder, and walnut. The examples here show the differences in grain and color. However it's best to keep in mind that the finish used affects the final color, so this isn't an exact match.

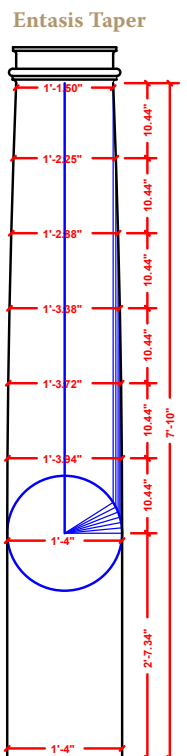

GREEK DORIC SPECIFICATION

Available in fluted or unfluted versions. They may be ordered in Vignola's architectural proportions or in custom combinations of column lengths and widths as well as in non-tapered cylinders. Square architectural columns and pilasters to match detail of round tapered columns are available.

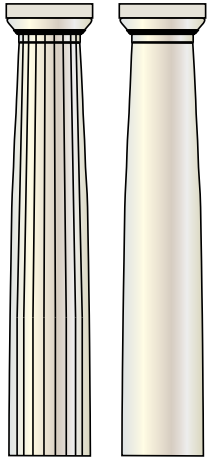
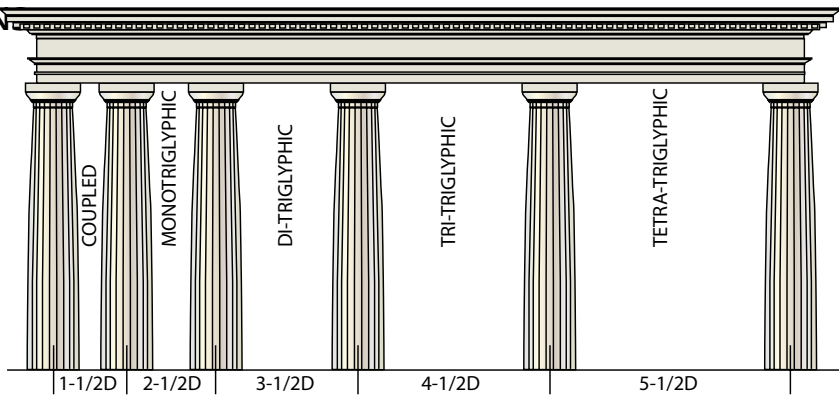
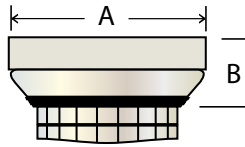

Shaft nominal bottom diameter	Shaft Specifications						Cap Specifications		
	Bottom		Top		Flutes		Specifications		Materials
	Net O.D.	Net I.D.	Net O.D.	Net I.D.	Number	Width	Abacus width (A)	Cap height (B)	
6"	6"	2 1/4"	5"	2"	20	1 5/16"	7 3/8"	2 11/16"	W
8"	8"	4 1/4"	6 1/2"	3 1/2"	20	1 1/4"	9 1/4"	3 5/16"	W
10"	10"	6 3/8"	8 1/4"	5 1/4"	20	1 9/16"	11 5/8"	3 15/16"	W
12"	12"	7 7/8"	9 3/4"	6 3/4"	20	1 7/8"	13 3/4"	4 7/8"	W
14"	14"	10 1/8"	11 1/4"	8 1/4"	20	2 3/16"	16"	5 1/2"	W
16"	16"	11 1/16"	12 3/4"	9 3/4"	20	2 1/2"	18 1/8"	6"	W
18"	18"	12"	14 1/2"	11 1/2"	20	2 13/16"	20 1/2"	6 3/4"	W
20"	20"	14 1/4"	16"	13"	20	3 1/8"	22 5/8"	7 3/8"	W
22"	22"	16 1/4"	18"	15"	20	3 7/16"	25 1/4"	8 1/4"	W
24"	24"	18 1/4"	19 1/2"	16 1/2"	20	3 3/4"	27 1/4"	8 7/8"	W

TUSCAN SPECIFICATIONS

Available in fluted or unfluted versions. They may be ordered in Vignola's architectural proportions or in custom combinations of column lengths and widths as well as in non-tapered cylinders. Square architectural columns and pilasters to match detail of round tapered columns are available.

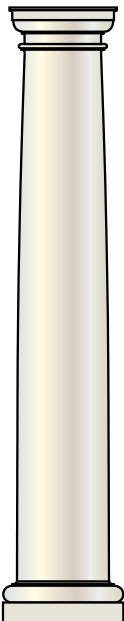
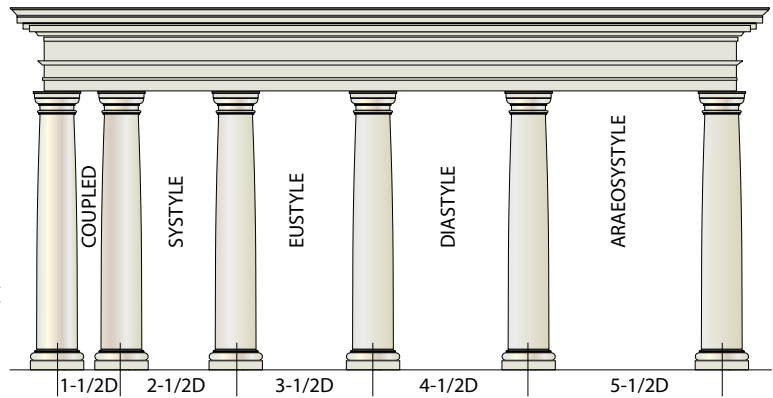
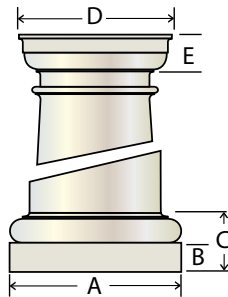

Shaft Nominal Bottom Diameter	Shaft Specifications						Tuscan Cap and Base Specifications					Materials
	Bottom		Top		Flutes		Base			Cap		
	Net O.D.	Net I.D.	Net O.D.	Net I.D.	Number	Width	Plinth width (A)	Plinth height (B)	Total height (C)	Abacus width (D)	Total height (E)	
4"	4"	0	3 1/4"	0	18	7/16"	5 3/8"	1"	2 5/16"	5 1/8"	1 3/16"	W P
6"	6"	3"	4 3/4"	2 1/2"	24	1/2"	8"	1 1/2"	3 1/4"	7 1/2"	1 3/4"	W P
8"	8"	5 1/4"	6 1/2"	4 3/8"	24	11/16"	10 3/4"	1 7/8"	4 1/4"	9 3/8"	2 3/8"	W P
10"	10"	7 1/4"	8 1/2"	6 3/8"	24	7/8"	13 3/8"	2 3/8"	5 1/4"	12 1/8"	3"	W P
12"	12"	9"	10"	7 3/4"	24	1"	16 1/8"	2 3/4"	6"	14 3/8"	3 3/8"	W P
14"	14"	10 1/8"	12"	9"	24	1 1/4"	18 3/4"	3 3/8"	7 3/8"	17 1/8"	4"	W P F
15"	15"	11 1/16"	12 3/4"	10"	24	1 11/32"	20 1/8"	3 5/8"	7 7/8"	18 3/16"	4 5/16"	W P
16"	16"	12"	13 1/2"	10"	24	1 7/16"	21 1/2"	3 7/8"	8 3/8"	19 1/4"	4 5/8"	W P F
18"	18"	14 1/4"	15"	12"	24	1 1/2"	24 1/4"	4 1/4"	9 5/8"	21 1/2"	5 1/8"	W F
20"	20"	16 1/4"	17"	13"	24	1 11/16"	27"	4 3/4"	10 3/4"	24 1/4"	5 5/8"	W F
22"	22"	18 1/4"	18 1/2"	15"	24	1 15/16"	29 3/4"	5 1/4"	12 1/8"	26 1/2"	6 1/4"	W F
24"	24"	20 1/4"	20"	17"	24	2 1/8"	32 1/2"	5 3/4"	13 1/4"	28 3/4"	6 7/8"	W F
26"	26"	22 1/8"	22"	19"	24	2 1/4"	35"	6 1/4"	14 1/2"	31 1/2"	7 3/8"	W F
28"	28"	24 1/8"	23 1/2"	21"	24	2 11/16"	38"	6 3/4"	15 1/2"	33 3/8"	8"	W F
30"	30"	26 1/4"	25"	22"	24	2 7/8"	40 1/2"	7 1/4"	16 1/2"	35 3/4"	8 5/8"	W F
32"	32"	27"	27"	23"	24	3"	42 3/4"	7 3/4"	17 3/4"	37 5/8"	9 1/4"	F
34"	34"	29"	28 1/2"	24 1/2"	24	3 1/4"	45 1/2"	8 1/2"	19 3/8"	41"	9 5/8"	F
36"	36"	31"	30"	26"	24	3 1/4"	48"	9"	20 3/8"	42 3/4"	10 1/2"	F

ROMAN DORIC SPECIFICATIONS

Available in fluted or unfluted versions. They may be ordered in Vignola's architectural proportions or in custom combinations of column lengths and widths as well as in non-tapered cylinders. Square architectural columns and pilasters to match detail of round tapered columns are available

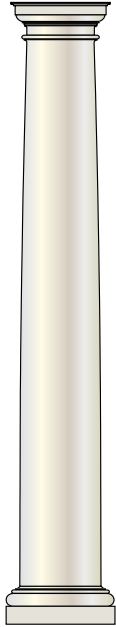
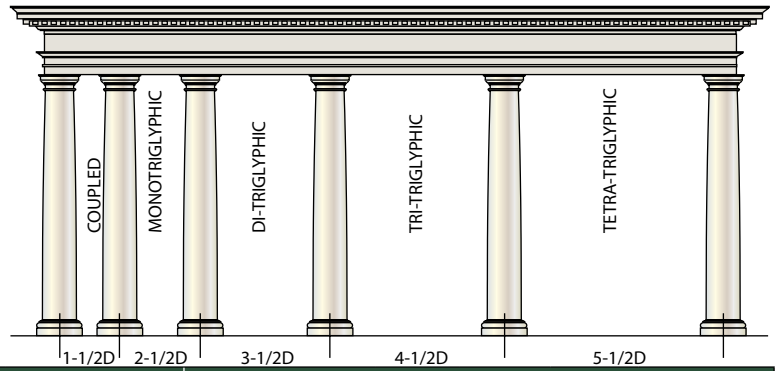
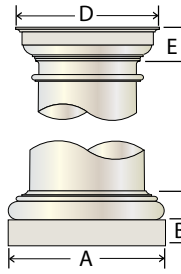

Shaft nominal bottom diameter	Shaft Specifications						Roman Doric Cap and Base Specifications						Materials Wood, Fiberglass, Polyurethane
	Bottom		Top		Flutes		Base			Cap			
	Net O.D.	Net I.D.	Net O.D.	Net I.D.	Number	Width	Plinth width (A)	Plinth height (B)	Total height (C)	Abacus width (D)	Total height (E)		
4"	4"	0	3 1/4"	0	18	7/16"	5 3/8"	1"	2 1/8"	5 1/8"	1 1/2"	W P	
6"	6"	3"	4 3/4"	2 1/2"	24	1/2"	8"	1"	3 1/4"	7 1/2"	2"	W P	
8"	8"	5 1/4"	6 1/2"	4 3/8"	24	11/16"	10 3/4"	1 7/8"	4 1/4"	9 3/4"	2 5/8"	W P	
10"	10"	7 1/4"	8 1/2"	6 3/8"	24	7/8"	13 3/8"	2 3/8"	5 3/8"	12 1/2"	3 1/8"	W P	
12"	12"	9"	10"	7 3/4"	24	1"	16 1/8"	2 3/4"	6 3/16"	14 3/4"	4"	W P	
14"	14"	10 1/8"	12"	9"	24	1 1/4"	18 3/4"	3 3/8"	7 3/8"	17 1/2"	4 11/16"	W P F	
15"	15"	11 1/16"	12 3/4"	10"	24	1 11/32"	20 1/8"	3 5/8"	8 1/16"	18 11/16"	5 1/32"	W P	
16"	16"	12"	13 1/2"	10"	24	1 7/16"	21 1/2"	3 7/8"	8 3/4"	19 7/8"	5 3/8"	W P F	
18"	18"	14 1/4"	15"	12"	24	1 1/2"	24 1/4"	4 1/4"	9 7/8"	22 1/4"	6"	W F	
20"	20"	16 1/4"	17"	13"	24	1 11/16"	27"	4 3/4"	11"	25"	6 3/4"	W F	
22"	22"	18 1/4"	18 1/2"	15"	24	1 15/16"	29 3/4"	5 1/4"	12"	27 3/8"	7 3/8"	W F	
24"	24"	20 1/4"	20"	17"	24	2 1/8"	32 1/2"	5 3/4"	13 1/4"	29 3/4"	7 15/16"	W F	
26"	26"	22 1/8"	22"	19"	24	2 1/4"	35"	6 1/4"	14 3/8"	32 1/2"	8 11/16"	W F	
28"	28"	24 1/8"	23 1/2"	21"	24	2 11/16"	38"	6 3/4"	15 3/8"	34 5/8"	9 3/8"	W F	
30"	30"	26 1/4"	25"	22"	24	2 7/8"	40 1/2"	7 1/4"	16 5/8"	37"	9 15/16"	W F	
32"	32"	27"	27"	23"	24	3"	42 3/4"	7 3/4"	17 3/4"	39 1/4"	10 9/16"	F	
34"	34"	29"	28 1/2"	24 1/2"	24	3 1/4"	45 1/2"	8 1/2"	19 1/4"	42 1/8"	11 5/16"	F	
36"	36"	31"	30"	26"	24	3 1/4"	48"	9"	20 1/4"	44 1/8"	12"	F	

ROMAN IONIC SPECIFICATIONS

Available in fluted or unfluted versions. They may be ordered in Vignola's architectural proportions or in custom combinations of column lengths and widths as well as in non-tapered cylinders.

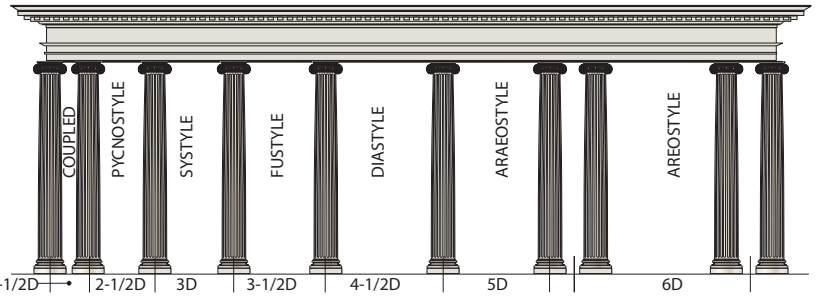
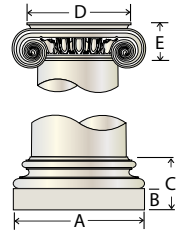

Shaft Nominal Bottom Diameter	Shaft Specifications						Base			Cap			
	Bottom		Top		Flutes		Attic Base Specifications			Materials Wood, Fiberglass, Polyurethane	Roman Ionic Specifications*		Materials Wood,** Composite, Poly/Resin
	Net O.D.	Net I.D.	Net O.D.	Net I.D.	Number	Width	Plinth Width (A)	Plinth Height (B)	Total height (C)		Abacus Width (D)	Capital Height (E)	
6"	6"	3"	4 3/4"	2 1/2"	24	1/2"	8"	1"	3 1/2"	W P	6 1/8"	2 1/4"	W C P
8"	8"	5 1/4"	6 1/2"	4 3/8"	24	11/16"	10 3/4"	1 7/8"	5 1/8"	W P	8 1/4"	3"	W C P
10"	10"	7 1/4"	8 1/2"	6 3/8"	24	7/8"	13 3/8"	2 3/8"	6 1/4"	W P	11"	3 5/8"	W C P
12"	12"	9"	10"	7 3/4"	24	1"	16 1/8"	2 3/4"	7 1/4"	W P	12 1/2"	4 1/2"	W C P
14"	14"	10 1/8"	12"	9"	24	1 1/4"	18 3/4"	3 3/8"	8 3/4"	W P F	17 1/2"	5 1/2"	C P
15"	15"	11 1/16"	12 3/4"	10"	24	1 11/32"	20 1/8"	3 5/8"	9 7/16"	W P	17 1/2"	5 1/2"	C P
16"	16"	12"	13 1/2"	10"	24	1 7/16"	21 1/2"	3 7/8"	10 1/8"	W P F	17 1/2"	6 1/8"	C P
18"	18"	14 1/4"	15"	12"	24	1 1/2"	24 1/4"	4 1/4"	11 3/8"	W F	20"	6 1/2"	C P
20"	20"	16 1/4"	17"	13"	24	1 11/16"	27"	4 3/4"	12 7/8"	W F	20"	6 1/2"	C P
22"	22"	18 1/4"	18 1/2"	15"	24	1 15/16"	29 3/4"	5 1/4"	14 1/4"	W F	25"	8 3/4"	C P
24"	24"	20 1/4"	20"	17"	24	2 1/8"	32 1/2"	5 3/4"	15 11/16"	W F	25 1/4"	9"	C
26"	26"	22 1/8"	22"	19"	24	2 1/4"	35"	6 1/4"	16 7/8"	W F	26 1/2"	9 1/2"	C
28"	28"	24 1/8"	23 1/2"	21"	24	2 11/16"	38"	6 3/4"	18 1/8"	W F	32"	12 1/2"	C
30"	30"	26 1/4"	25"	22"	24	2 7/8"	40 1/2"	7 1/4"	19 1/4"	W F	32"	12 1/2"	C

*Sizes shown for Roman Ionic Cap. See Ornamental Capital table for sizes of all available styles.
 **Not all capital styles available in wood, not all styles in all sizes.

ROMAN CORINTHIAN SPECIFICATIONS

Corinthian Columns are available in fluted or unfluted versions. They may be ordered in Vignola's architectural proportions or in custom combinations of column lengths and widths as well as in non-tapered cylinders. Square architectural columns and pilasters to match detail of round tapered columns are available.

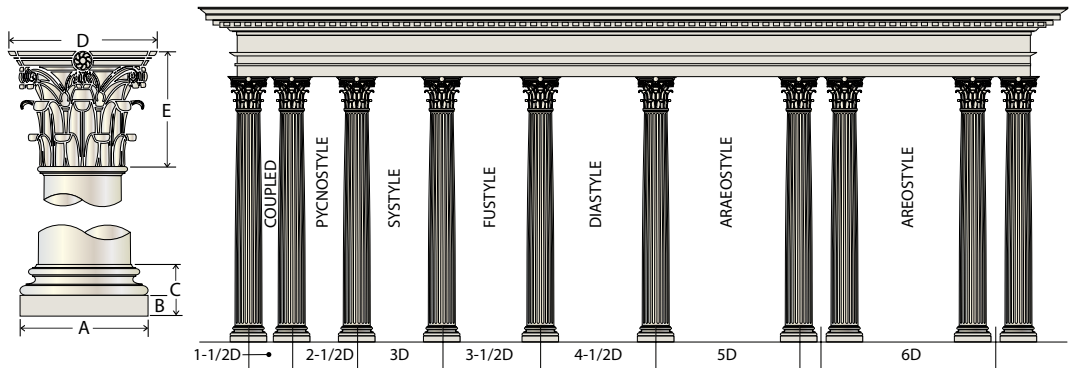

Shaft nominal bottom diameter	Shaft Specifications						Roman Corinthian Base			Roman Corinthian Cap			
	Bottom		Top		Flutes		Attic Base Specifications			Materials Wood, Fiberglass, Polyurethane	Specifications		Materials Wood, Composite, Poly/Resin
	Net O.D.	Net I.D.	Net O.D.	Net I.D.	Number	Width	Plinth width (A)	Plinth height (B)	Total Height (C)		Abacus width (D)	Total height (E)	
6"	6"	3"	4 3/4"	2 1/2"	24	1/2"	8"	1"	3 1/2"	W P F E	9 1/2"	7"	W C P
8"	8"	5 1/4"	6 1/2"	4 3/8"	24	11/16"	10 3/4"	1 7/8"	5 1/8"	W P F E	12"	8 1/2"	W C P
10"	10"	7 1/4"	8 1/2"	6 3/8"	24	7/8"	13 3/8"	2 3/8"	6 1/4"	W P F E	15"	12"	W C P
12"	12"	9"	10"	7 3/4"	24	1"	16 1/8"	2 3/4"	7 1/4"	W P F E	18 1/2"	14 1/2"	W C P
14"	14"	10 1/8"	12"	9"	24	1 1/4"	18 3/4"	3 3/8"	8 3/4"	W P F E	22"	17"	C P
15"	15"	11 1/16"	12 3/4"	10"	24	1 11/32"	20 1/8"	3 5/8"	9 7/16"	W P F E	22"	17"	C P
16"	16"	12"	13 1/2"	10"	24	1 7/16"	21 1/2"	3 7/8"	10 1/8"	W P F E	27"	20"	C P
18"	18"	14 1/4"	15"	12"	24	1 1/2"	24 1/4"	1 1/4"	11 3/8"	W F E	32 1/2"	23"	C P
20"	20"	16 1/4"	17"	13"	24	1 11/16"	27"	4 3/4"	12 7/8"	W F E	39"	25 1/2"	C P
22"	22"	18 1/4"	18 1/2"	15"	24	1 15/16"	29 3/4"	5 1/4"	14 1/4"	W F E	42"	28 1/2"	C P
24"	24"	20 1/4"	20"	17"	24	2 1/8"	32 1/2"	5 3/4"	15 11/16"	W F E	42"	28 1/2"	C P
26"	26"	22 1/8"	22"	19"	24	2 1/4"	35"	6 1/4"	16 7/8"	W F E	42"	32"	C
28"	28"	24 1/8"	23 1/2"	21"	24	2 11/16"	38"	6 3/4"	18 1/8"	W F E	46"	34"	C
30"	30"	26 1/4"	25"	22"	24	2 7/8"	40 1/2"	7 1/4"	19 1/4"	W F E	46 1/2"	37 1/2"	C

CALCULATED SAFE-LOAD CAPACITIES

Diameter	Pine	Cedar	Available Heights*
6"	2,567 lb.	5,146 lb.	3' to 10'
8"	4,114 lb.	7,646 lb.	4' to 12'
10"	5,497 lb.	10,474 lb.	5' to 16'
12"	6,620 lb.	12,535 lb.	6' to 20'
14"	11,017 lb.	15,282 lb.	6' to 20'
16"	12,307 lb.	17,343 lb.	6' to 24'
18"	14,487 lb.	19,404 lb.	6' to 24'
20"	16,688 lb.	22,151 lb.	6' to 30'
22"	18,426 lb.	24,212 lb.	8' to 30'
24"	20,018 lb.	26,272 lb.	8' to 30'
26"	22,252 lb.	36,870 lb.	8' to 30'
28"	24,001 lb.	39,519 lb.	8' to 30'
30"	25,746 lb.	42,169 lb.	8' to 30'
32"	42,080 lb.	55,317 lb.	8' to 30'
34"	44,567 lb.	57,476 lb.	8' to 30'
36"	47,054 lb.	61,794 lb.	8' to 30'

The sample columns tested supported loads at least four times the calculated values to the left prior to failure. The load was applied concentrically through the axis of the column. Loads shown are valid only if there is uniform contact between the full area of column ends and the cap and base units. Loads are provided for your convenience only and are not exact values. Consult a structural engineer for the most accurate load estimates.

* Custom sizes available on request.

PLAN TYPES

Architectural Columns are available in the following plan types. Please specify when you order. Custom plan types are also available. (Fractional components shown are typical. Customer may specify actual returns, wall thicknesses, etc).

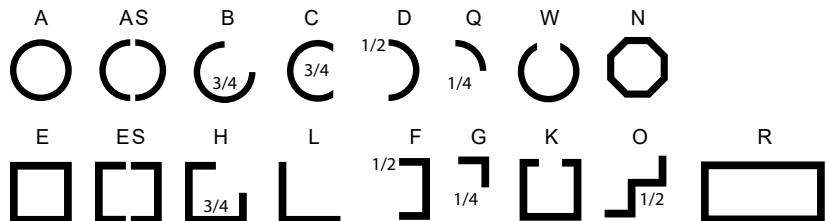



ORNAMENTAL CAPITALS FOR ARCHITECTURAL WOOD COLUMNS

Shaft nominal bottom width	1 Empire			2 Empire with Necking			3 Greek Erectheum			4 Scamozzi			5 Greek Erectheum with Necking		
	Abacus width	Capital height	Scroll width	Abacus width	Capital height	Scroll width	Abacus width	Capital height	Scroll width	Abacus width	Capital height	Scroll width	Abacus width	Capital height	Scroll width
6"	9"	3 1/8"	8 3/4"	9"	6 7/8"	8 3/4"	6 3/4"	3 1/4"	8 1/2"	7 3/4"	2 5/8"	6 1/4"	n/a		
8"	10"	3 3/4"	9"	10"	7 3/4"	9"	7 3/4"	4 1/2"	11 3/4"	10 1/4"	3"	9"	n/a		
10"	16"	5 1/2"	13 1/2"	13 1/2"	10"	12 1/4"	12"	5 1/2"	17 1/2"	16"	4 1/2"	14"	n/a		
12"	18"	6 3/4"	17"	18"	11"	17"	14 1/2"	6 1/4"	21"	17 1/2"	5"	15 1/2"	14 1/2"	9 1/2"	21"
14"	20 1/2"	7 1/4"	19 1/2"	20 1/2"	14 1/2"	19 1/2"	15"	7"	21"	19 1/2"	6"	16 1/2"	15"	11 1/4"	21"
15"	23"	8 3/4"	19 1/2"	20 1/2"	14 1/2"	19 1/2"	n/a			19 1/2"	6"	16 1/2"	15"	11 1/4"	21"
16"	23"	8 3/4"	19 1/2"	23"	17"	19 1/2"	17 1/2"	9"	26"	22 1/4"	6 1/4"	18 1/2"	17 1/2"	13 1/2"	26"
18"	32"	10"	25 1/4"	32"	15"	26 1/4"	22"	10 1/4"	29"	25"	7 1/2"	20 1/4"	22 1/2"	15"	29"
20"	34"	11 1/4"	28"	34"	17 1/4"	28"	26"	11"	36"	28 1/2"	8 1/2"	24"	26"	17"	36"
22"	35 1/2"	12 3/4"	35"	34"	17 1/4"	28"	26"	11 1/4"	36 1/4"	28 1/2"	8 1/2"	24"	26"	17"	36"
24"	35 1/2"	12 3/4"	35"	35 1/2"	19"	35"	30 1/2"	13"	43"	34 1/4"	10 1/4"	29 1/2"	30 1/2"	19"	43"
26"	37"	13"	35"	37"	19"	35"	32 1/2"	13"	43"	35 1/4"	11"	29 3/4"	32 1/2"	19 1/2"	43"
28"	n/a			37"	19"	35"	31"	15"	45 1/2"	39"	12 3/4"	33"	31"	24 3/4"	45 1/2"
30"	n/a			n/a			31"	15"	45 1/2"	39"	12 3/4"	33"	31"	24 3/4"	45 1/2"
36"	n/a			n/a			42 1/2"	19 1/4"	60 1/2"	46"	15"	38 1/2"	n/a		

Shaft nominal bottom width	6 Roman Corinthian		7 Roman Doric Ornamental		8 Modern Composite		9 Roman Ionic			10 Greek Angular Ionic			11 Temple of Winds	
	Abacus width	Capital height	Abacus width	Capital height	Abacus width	Capital height	Abacus width	Capital height	Scroll width	Abacus width	Capital height	Scroll width	Abacus width	Capital height
4"	n/a		n/a		n/a		n/a			n/a			6"	6"
6"	9 1/2"	7"	8 3/4"	4"	8"	7"	6 1/8"	2 1/4"	8 1/16"	n/a			8"	7"
8"	12"	8 1/2"	13 1/8"	6"	10 3/4"	8 1/2"	8 1/4"	3"	10 1/2"	9 1/2"	3 3/4"	9"	10 1/2"	7 1/2"
10"	15"	12"	14 1/4"	6 3/4"	16 1/2"	11 1/2"	11"	3 5/8"	13 5/8"	14 1/2"	5 3/8"	13 1/4"	15 1/4"	11 1/8"
12"	18 1/2"	14 1/2"	16 1/4"	7"	19"	14 1/2"	12 1/2"	4 1/2"	16 1/2"	17 1/4"	6"	17"	16 7/8"	11 5/8"
14"	22"	17"	21"	9"	20"	17"	17 1/2"	5 1/2"	23"	20 3/4"	7 1/4"	19 1/4"	21 1/4"	14"
15"	22"	17"	24"	10 1/2"	20"	17"	17 1/2"	6 1/8"	22"	20 1/2"	8 3/8"	19 1/2"	21 1/4"	14"
16"	27"	20"	24"	10 1/2"	n/a		17 1/2"	6 1/8"	22"	20 1/2"	8 3/8"	19 1/2"	23"	16"
18"	32 1/2"	23"	28"	12 1/2"	25"	22 1/2"	20"	6 1/2"	24 1/4"	24 1/4"	9 3/4"	19 3/4"	26 3/4"	18 1/8"
20"	39"	25 1/2"	n/a		25"	22 1/2"	25"	8 3/4"	31 3/4"	29 3/4"	11"	28"	28"	21 1/2"
22"	42"	28 1/2"	n/a		n/a		25"	8 3/4"	31 3/4"	29 3/4"	11"	28"	34 1/2"	23 1/4"
24"	42"	28 1/2"	n/a		n/a		25 1/4"	9"	33"	35"	12 3/4"	34 1/2"	31 1/4"	28 1/2"
26"	42"	32"	n/a		n/a		26 1/2"	9 1/2"	33 3/4"	39 1/2"	14 3/4"	38"	35"	24"
28"	46"	34"	n/a		n/a		32"	12 1/2"	40 1/2"	39 1/2"	14 3/4"	38"	37"	28"
30"	46 1/2"	37 1/2"	n/a		n/a		32"	12 1/2"	40 1/2"	n/a			39"	30"
36"	55"	42"	n/a		n/a		n/a			n/a			n/a	



Plaster Ornamental Capitals are coated with boiled linseed oil and turpentine as a temporary protector until they can be primed and coated with at least two coats of oil-base paint on the inside and outside. (If capitals are allowed to gather moisture before painting, peeling is likely to occur and further coating will be futile.) Ornamental Capitals are shipped with a load-bearing plug, which must bear the weight of any load on the column. Specifications and materials are subject to change without notice. Poly/Resin Capitals are load bearing, and do not require plugs.

Exterior and paint-grade interior columns feature polyurethane or fiberglass caps and bases (see charts) to provide crisp, true architectural detail and increased durability. Special-order wood caps and bases are available. Optional aluminum plinths provide an extra measure of protection.



TURNCRAFT

COL *Colonial Column*

- READY TO INSTALL
- DECORATIVE CAPITALS AVAILABLE
- SELECT SIZES AVAILABLE FOR QUICK SHIP
- 6" - 12" TREATED WITH WOODLIFE® 111
- READY TO PRIME AND PAINT
- WOOD CAPS AND BASES AVAILABLE FOR INTERIOR USE
- POLYURETHANE CAPS AND BASES AVAILABLE FOR EXTERIOR USE

PRECISION CRAFTSMANSHIP

Turncraft Wood Colonial columns begin with the milling of finger-jointed or solid staves to exacting dimension. The staves are then assembled into a raw shaft using the strongest Type-I waterproof glue. Torque bands are wrapped around the shaft applying 90 to 100 pounds of pressure per square inch, transforming the individual staves into a single unit, ready for precision turning.

TREATED AND PROTECTED WITH WOODLIFE® 111

All exterior columns manufactured by Turncraft are treated with Woodlife® 111 water repellent (unless factory primed), which provides maximum protection against mold, mildew, staining and decaying fungi. This also increases dimensional stability and helps prevent shrinkage.

AVAILABILITY

Turncraft manufactures a full selection of Colonial design columns in a variety of wood species. Diameters ranging from 6" to 24" in two-inch increments. Heights range from 4' to 30' in two-foot increments. Turncraft Architectural offers a wider range of sizes and styles - 4" through 36".

UPON REQUEST:

Priming is applied in two coats, using a specially formulated primer developed exclusively for Turncraft. The column is sanded before each coat.

Asphalt coating of the shaft interior is applied to the bottom three feet of the shaft.



PLAN TYPES

Colonial columns are available in the following plan types. Please specify when you order. Columns other than Plan Type A are not load bearing. Split or reassembled columns are not load bearing.

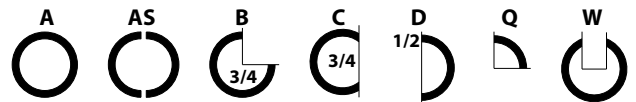

Colonial
Tapered
Round
Smooth



Colonial
Tapered
Round
Fluted

COLONIAL TAPERED COLUMN SPECIFICATIONS

Nominal Shaft Diameter *	Available Heights	Shaft Dimensions				Fluting Dimensions			Maximum Load (pounds) Capacity
		Outside Diameter		Inside Diameter		Number of Flutes	Flutes Width	Flute Length (A)	
		Bottom	Top	Bottom	Top				
6"	6'	5 5/8"	4 1/4"	3"	1 3/4"	15	1/2"	4'-2"	2,095 lb.
	8'							6'-2"	
	10'							8'-2"	
	12'							10'-2"	
	14'							12'-2"	
	16'							14'-2"	
8"	6'	7 5/8"	6 1/4"	5"	3 1/2"	15	7/8"	4'-2"	3,258 lb.
	8'							6'-2"	
	10'							8'-2"	
	12'							10'-2"	
	14'							12'-2"	
	16'							14'-2"	
10"	6'	9 5/8"	8 1/4"	7 1/8"	5 1/2"	18	7/8"	4'-2"	4,268 lb.
	8'							6'-2"	
	10'							8'-2"	
	12'							10'-2"	
	14'							12'-2"	
	16'							14'-2"	
12"	6'	11 5/8"	10 1/4"	9"	7 1/2"	20	7/8"	4'-2"	5,173 lb.
	8'							6'-2"	
	10'							8'-2"	
	12'							10'-2"	
	14'							12'-2"	
	16'							14'-2"	
14"	6'	13 5/8"	11"	10 3/4"	7 3/4"	24	7/8"	4'-2"	6,808 lb.
	8'							6'-2"	
	10'							8'-2"	
	12'							10'-2"	
	14'							12'-2"	
	16'							14'-2"	
16"	6'	15 5/8"	13"	13"	10"	24	1"	4'-1"	8,618 lb.
	8'							6'-1"	
	10'							8'-1"	
	12'							10'-1"	
	14'							12'-1"	
	16'							14'-1"	
18"	6'	17 5/8"	15"	14 3/4"	12"	27	1"	3'-10"	10,624 lb.
	8'							5'-10"	
	10'							7'-10"	
	12'							9'-10"	
	14'							11'-10"	
	16'							13'-10"	
20"	6'	19 5/8"	17"	16 7/8"	14"	27	1"	3'-10"	11,915 lb.
	8'							5'-10"	
	10'							7'-10"	
	12'							9'-10"	
	14'							11'-10"	
	16'							13'-10"	
24"	6'	23 5/8"	21"	20 1/4"	17 3/4"	30	1 1/2"	3'-10"	20,974 lb.
	8'							5'-10"	
	10'							7'-10"	
	12'							9'-10"	
	14'							11'-10"	
	16'							13'-10"	

Custom flute lengths are available upon request, for the same price as standard fluted columns. Fluting typically ends 4" from the base on custom fluted columns. If using standard height columns with custom height columns, it is best to order the standard height columns custom fluted as well to match the 4" bottom spacing.

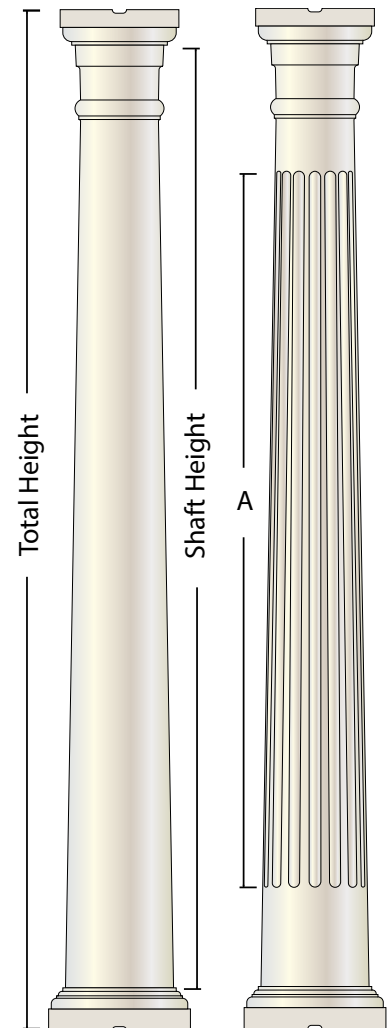
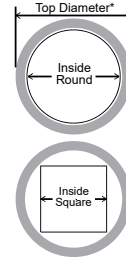

* Shaft net diameters are 3/8" less than nominal.

** For wood columns, inside sizes are based on the inside diameter of the polyurethane cap. Other caps (wood and ornamental capitals) have different sizes and these numbers will not apply.

Turncraft manufactures a full selection of Colonial design columns in finger-joint western pine. Other species may be available upon request.

POLYURETHANE TAPERED

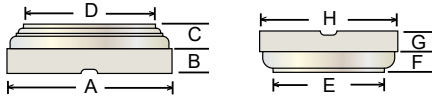

Shaft Bottom Diameter*	Bases				Caps			
	Plinth		Base Round		Cap Round		Abacus	
	A	B	C	D	E	F	G	H
6"	8 3/16"	1 7/16"	1 7/16"	6 1/8"	5 1/8"	1 1/4"	1 1/4"	6 13/16"
8"	10 1/8"	1 7/16"	1 7/16"	8"	6 3/4"	1 1/4"	1 1/4"	8 1/2"
10"	12 3/16"	1 7/16"	1 7/16"	10"	8 7/8"	1 1/2"	1 3/8"	10 1/2"
12"	14 1/8"	1 7/16"	1 7/16"	12"	10 3/8"	1 1/2"	1 3/8"	12 1/8"
14"	16 3/8"	2 1/4"	2 1/4"	14"	12"	2 1/4"	2 1/4"	14"
16"	18 3/4"	2 3/8"	2 5/16"	16 3/8"	13 3/4"	2 3/8"	2 3/8"	16"
18"	21 5/8"	3 3/16"	3 3/16"	18 1/2"	15 3/4"	3 1/8"	3 1/4"	18 3/4"
20"	23 3/4"	3 3/8"	3 1/8"	20 1/2"	17 5/8"	3 1/4"	3 1/4"	20 5/8"
22"	25"	3 5/16"	3 5/16"	22"	19 3/4"	3 5/16"	3 5/16"	22 3/4"
24"	28 1/2"	3 5/16"	3 5/16"	24"	21 3/4"	3 5/16"	3 5/16"	25"

FJ PINE TAPERED

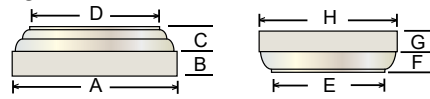

Shaft Bottom Diameter*	Bases				Caps			
	Plinth		Base Round		Cap Round		Abacus	
	A	B	C	D	E	F	G	H
6"	8 1/8"	1 7/16"	1 7/16"	6 1/8"	5 1/8"	1 1/4"	1 1/4"	6 3/4"
8"	10"	1 7/16"	1 7/16"	8"	6 3/4"	1 1/4"	1 1/4"	8 3/4"
10"	12"	1 7/16"	1 7/16"	10"	8 7/8"	1 7/16"	1 7/16"	10 3/8"
12"	14"	1 7/16"	1 7/16"	12"	10 3/8"	1 7/16"	1 7/16"	12"

ORNAMENTAL CAPITALS FOR ROUND TAPERED COLONIAL COLUMNS



Nominal Bottom Diameter	Empire				Empire with Necking				Greek Angular Ionic			
	Capital Height	Abacus Width	Scroll Width	Height Adjust	Capital Height	Abacus Width	Scroll Width	Height Adjust	Capital Height	Abacus Width	Scroll Width	Height Adjust
6"	2 1/2"	7 1/2"	6 3/4"	-4 3/8"	5"	7 1/2"	6 3/4"	-1 1/4"	2 3/4"	7 1/2"	6 3/4"	-4 1/8"
8"	3 3/4"	10"	9"	-3 1/8"	7 3/4"	10"	9"	1 1/2"	3 5/8"	9 1/4"	9"	-3 1/4"
10"	5 1/4"	10 3/8"	12 1/4"	-2"	10"	13 1/2"	12 1/4"	3 3/8"	5 1/8"	14 1/4"	13 3/4"	-2 1/8"
12"	6 1/4"	18"	17"	-1"	11"	18"	17"	4 3/8"	6"	17 1/4"	17"	-1 1/4"
14"	6 1/4"	18"	17"	-3 5/16"	11"	18"	17"	2 7/16"	6"	17 1/4"	18 1/4"	-3 9/16"
16"	7 1/2"	20 3/8"	19 1/2"	-2 5/16"	14 1/2"	20 1/2"	19 1/2"	5 11/16"	7 1/4"	20 3/4"	19 1/4"	-2 9/16"
18"	8 3/4"	23"	19 1/2"	-2 11/16"	17"	23"	19 1/2"	6 9/16"	8 3/8"	20 1/2"	19 1/2"	-3 1/16"
20"	10"	30 3/4"	26 1/4"	-1 9/16"	15"	32"	26 1/4"	4 7/16"	9 3/4"	24 1/4"	19 3/4"	-1 13/16"
22"	11 1/4"	34"	28"	-7/8"	17 1/4"	34"	28"	6 3/8"	11"	29 3/4"	28"	-1 1/8"
24"	12 3/4"	35 1/2"	35"	1"	19"	35 1/2"	35"	8 1/2"	12 3/4"	35"	34 1/2"	1"



Nominal Bottom Diameter	Greek Erectheum				Greek Erectheum with Necking				Modern Composite		
	Capital Height	Abacus Width	Scroll Width	Height Adjust	Capital Height	Abacus Width	Scroll Width	Height Adjust	Capital Height	Abacus Width	Height Adjust
6"	3 1/4"	6 3/4"	8 1/2"	-3 5/8"	N/A				6 1/2"	7 1/2"	1/4"
8"	3 3/4"	7 3/4"	11 3/4"	-3 1/8"	5 3/4"	7 3/4"	11 3/4"	-1/2"	8 1/2"	10 3/4"	2 1/4"
10"	5 1/4"	10 1/2"	15"	-2"	7 1/2"	10 1/2"	15"	7/8"	11 1/2"	16 1/2"	4 7/8"
12"	6 1/4"	14 1/2"	21"	-1"	8 1/2"	12"	17 1/4"	1 7/8"	12 1/4"	16 1/2"	5 5/8"
14"	7 1/4"	15 1/4"	20 3/8"	-2 5/16"	9 1/2"	14 1/2"	21"	15/16"	14 1/2"	19"	5 15/16"
16"	7"	15"	20 3/4"	-2 13/16"	11 1/4"	15"	21"	2 7/16"	17"	20"	8 3/16"
18"	9 1/4"	17 1/2"	25 7/8"	-2 3/16"	13 1/2"	17 1/2"	26"	3 1/16"	N/A	N/A	N/A
20"	10"	22 1/2"	29"	-1 9/16"	15"	22 1/2"	29"	4 7/16"	22 1/2"	25"	11 15/16"
22"	11"	26"	36"	-1 1/8"	17"	26"	36"	6 1/8"	N/A		
24"	13"	30 1/2"	43"	1 1/4"	19"	30 1/2"	43"	8 1/2"	N/A		

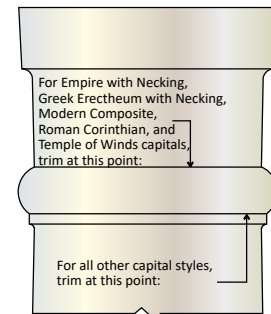

Nominal Bottom Diameter	Roman Corinthian			Roman Doric Ornamental			Roman Ionic				Scamozzi				Temple of Winds		
	Capital Height	Abacus Width	Height Adjust	Capital Height	Abacus Width	Height Adjust	Capital Height	Abacus Width	Scroll Width	Height Adjust	Capital Height	Abacus Width	Scroll Width	Height Adjust	Capital Height	Abacus Width	Height Adjust
6"	5 3/4"	7 7/8"	-1/2"	4"	8 3/4"	-2 1/4"	2 1/4"	6 1/8"	8 1/16"	-4 5/8"	2 1/2"	6 1/2"	5 1/4"	-4 3/8"	6"	6"	-1/4"
8"	8"	9 3/8"	1 3/4"	4 1/2"	10 1/2"	-1 3/4"	3"	8 1/4"	10 1/2"	-3 7/8"	2 7/8"	10"	8"	-4"	7"	8"	3/4"
10"	11"	13"	4 3/8"	6"	14 1/4"	-5/8"	3 5/8"	10 1/2"	13 1/2"	-3 5/8"	3 1/2"	11"	9 3/8"	-3 3/4"	10"	13 5/8"	3 3/8"
12"	13 7/8"	17 3/4"	7 1/4"	7"	16 1/4"	-3/8"	4 1/2"	12 1/2"	16 1/2"	-2 3/4"	4 7/8"	16 3/8"	15 5/8"	-2 3/8"	11 3/8"	16 1/2"	4 3/4"
14"	14 5/8"	17 3/4"	6 1/16"	7 1/8"	16 1/8"	-1 7/16"	4 3/4"	12 7/8"	16"	-4 13/16"	5 1/8"	16 1/4"	15 5/8"	-4 7/16"	11 1/4"	16 1/2"	2 11/16"
16"	17 1/8"	22 1/2"	8 5/16"	7 1/4"	17 5/8"	-1 9/16"	5 5/8"	17 3/8"	22 3/4"	-4 3/16"	5 3/4"	18 1/2"	18 5/8"	-4 1/16"	16"	18 7/8"	7 3/16"
18"	17 5/8"	23 3/8"	7 3/16"	10 1/2"	24"	1/16"	6 3/8"	18"	23 1/2"	-5 1/16"	6 1/4"	22 1/2"	18 1/2"	-5 3/16"	16"	23"	5 9/16"
20"	23"	31 5/8"	12 7/16"	12 1/2"	28"	1 15/16"	6 1/4"	20"	24 1/4"	-5 5/16"	7 1/2"	25"	20 1/4"	-4 1/16"	18 3/8"	26"	7 13/16"
22"	25 7/8"	32 3/8"	15"	N/A			9 1/4"	25 1/8"	31 3/8"	-2 7/8"	8 1/2"	26 3/4"	34 5/8"	-3 5/8"	21 3/8"	28 3/8"	10 1/2"
24"	27 3/4"	42"	17 1/4"	N/A			9"	25 1/4"	33"	-2 3/4"	10 1/4"	34 1/4"	29 1/2"	-1 1/2"	26"	30 7/8"	15 1/2"



TURNCRAFT

SWC

Square Wood Columns

- READY TO INSTALL
- STRUCTURAL, LOAD-BEARING
- POST DEFENSE™ SEALER
- FACTORY SANDED AND PRIMED FOR EASY FINISHING
- EASY TO ATTACH RAILINGS
- INCLUDES MULTIPLE CAP AND BASE OPTIONS
- DESIGNED FOR INTERIOR OR EXTERIOR USE
- LIMITED LIFETIME WARRANTY

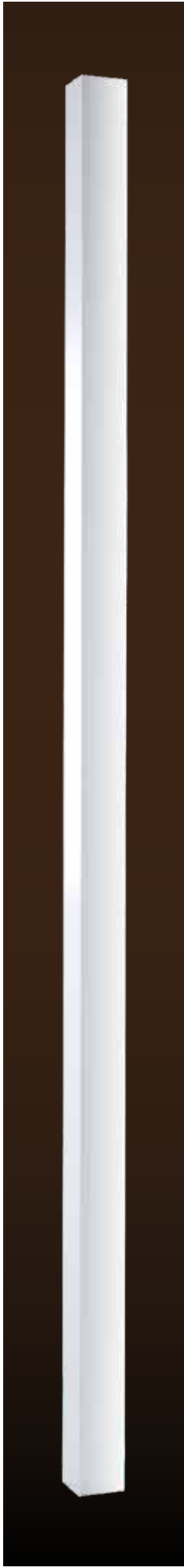

Nominal	NET	Shaft height	Load capacity	Item #
4"	3 3/16"	8'	1,000	D8248A
		9'	1,000	D8249A
		10'	1,000	D8370A
5"	4 3/16"	8'	3,000	D8258A
		9'	3,000	D8259A
		10'	3,000	D8375A
6"	5 3/16"	8'	5,800	D8268A
		9'	5,800	D8269A
		10'	5,800	D8380A

ADDED PROTECTION
Special formulated end-seal added to the bottom of each column.

POST SAVER™
Designed and engineered to work perfectly with square columns. (Required for warranty)

LIMITED
LIFETIME
COLUMN
DEFENSE™
WARRANTY

STANDARD CAP & BASE

Size	Width	Height	Item #
4"	4 5/8"	3"	PW04
5"	5 5/8"	3"	PW05
6"	6 5/8"	3"	PW06

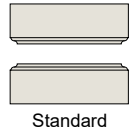

CROWN CAP & BASE

Size	Width	Height	Item #
6"	11"	3"	PW0406

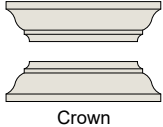

MISSION CAP & BASE

Size	Width	Height	Item #
6"	7-1/4"	5 1/4"	PW1606

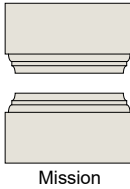

POSTSAVER™
(required for warranty)

Size	Item #
4"	A2101
5"	A2102
6"	A2103



PRAIRIE CAP & BASE

Size	Width	Height	Item #
6"	7 1/2"	3 1/4"	PW1206

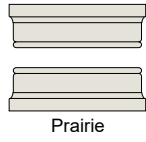

TUSCAN CAP & BASE

Size	Width	Height	Item #
6"	7 3/8"	3 1/4"	PW0206

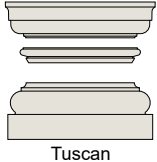



TURNCRAFT

WPP

Post Defense

- REAL WOOD TURNINGS
- SANDED AND PRIMED FOR EASY FINISHING
- SPECIAL SEALER APPLIED TO BOTTOM OF POSTS
- POST-SAVER™ FASTENERS
- POST DEFENSE™ LIMITED LIFETIME WARRANTY
- READY TO PAINT
- 4", 5" AND 6" SIZES
- 8', 9' AND 10' LENGTHS



COLONIAL PORCH POST

Bottom width	Shaft height	Load capacity	Item number
4"	8'	1,000	D3148A
	9'	1,000	D3049A
	10'	1,000	D3410A
5"	8'	3,000	D3158A
	9'	3,000	D3059A
	10'	3,000	D3510A
6"	8'	5,800	D3168A
	9'	5,800	D3069A
	10'	5,800	D3610A

SQUARE PORCH POST

Bottom width	Shaft height	Load capacity	Item number
4"	8'	1,000	D8248A
	9'	1,000	D8249A
	10'	1,000	D8370A
5"	8'	3,000	D8258A
	9'	3,000	D8259A
	10'	3,000	D8375A
6"	8'	5,800	D8268A
	9'	5,800	D8269A
	10'	5,800	D8380A

CHAMFERED PORCH POST

Bottom width	Shaft height	Load capacity	Item number
5"	8'	3,000	D8258AC
	9'	3,000	D8259AC
	10'	3,000	D8375AC
6"	8'	5,800	D8268AC
	9'	5,800	D8269AC
	10'	5,800	D8380AC

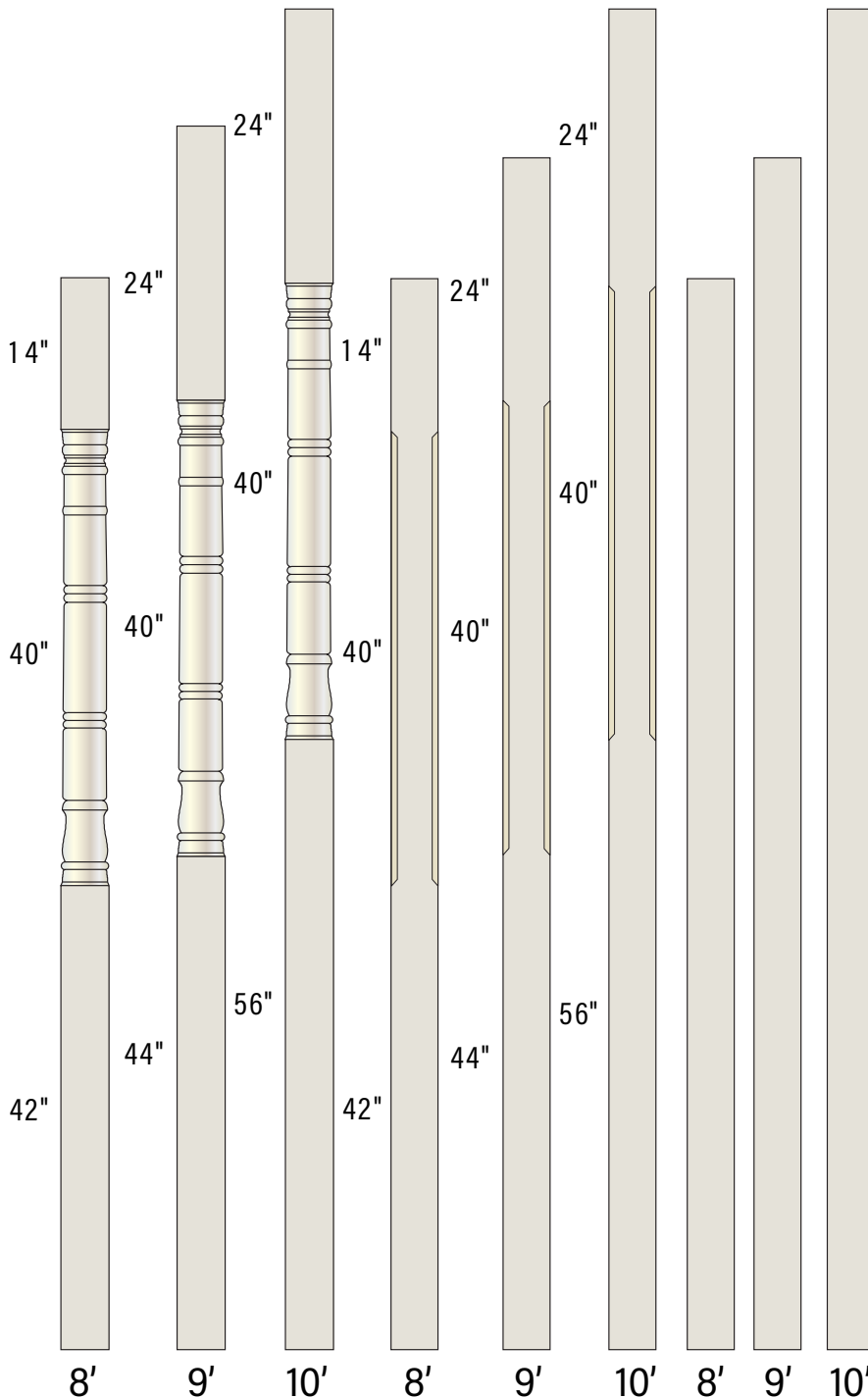

POSTSAVER™
(required for warranty)

Size	Item #
4"	A2101
5"	A2102
6"	A2103

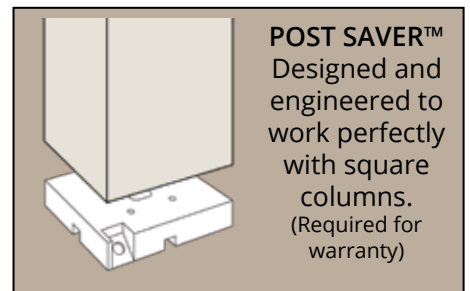

POST TRIM KIT

The new PVC porch post Trim kit is designed to wrap around the porch post and mounting (Post Saver™, plinth, etc.) for a finished look.



Visit Turncraft's Website

COLUMN BUILDER PDF CREATOR

Our interactive column builder will allow you to choose the column, capital and base of your choice. When you have designed the column you can save it to a PDF for printing. Take the PDF to your local Turncraft distributor for pricing and availability.

Column Builder also available for all IOS phones and tablets.



PHOTO GALLERY

- View Turncraft products installed in various locations.

LITERATURE BROWSER

- Quick access to all the literature offered on Turncraft website.

ARCHITECT'S CORNER

- Specifications and instructions for the architect.

PRODUCTS

You can select any of our product lines by clicking on the desired column.

- Turncraft Architectural Wood Columns
- Poly-Classic® FRP Columns
- DuraGlass™ Columns
- Craftsman Columns
- Porch Post
- Wood Colonial Columns
- Wood Square Columns
- Wood Porch Posts

Clicking on the product tab will pull up all the information available for that particular product.

ADDITIONAL INFORMATION

All of the information available in PDF format will be available here for your selection. Simply click on the desired PDF to view, save or print it out.

- Installation instructions
- Warranty information
- Specifications
- Catalog PDF

Turncraft Column Builder App Available in App Store



find us on:



Quality at Every Turn

At Turncraft the quality starts with the materials.

As a division of Cascade Wood Products, we have direct control of the raw materials used in our wood products. Unlike other column manufacturers, our ability to monitor materials at each step of the process ensures every Turncraft wood column will offer both the natural beauty and the quality needed to stand the test of time. Quality control is further improved by using specialized machinery unique to each product line. By keeping our manufacturing facilities separate, we can better monitor, control and improve how well and how efficiently all of our products are constructed.



Thoughtful design, exceptional materials and fine workmanship.

CREATING BEAUTY IS AN EXACTING PROCESS.

For Architectural Series columns, finger-jointed* or solid staves are milled to required dimensions, assembled using the strongest Type-I waterproof glue, then metal-banded for curing. A computer-controlled lathe turns the assembled shaft to the precise taper desired, complete with true architectural entasis. The top is profiled, the entire column is machine sanded and flutes are milled at precise intervals and depths, ending in half-rounds at the top and bottom (except on Greek Doric).



Computer-guided precision is our trademark.

ALTERNATIVE BUILDING MATERIALS.

Turncraft has responded to the growing demand for alternative building materials. In 1994, we introduced our Poly-Classic® line of fiberglass-reinforced polymer (FRP) columns to offer customers a more versatile and durable alternative. In 2005, we added the Poly-Classic® Craftsman line—a popular design made of expanded cellular PVC for easy assembly and virtually maintenance-free performance.

CUSTOM SOLUTIONS.

While Turncraft offers an extremely diverse lineup of products in more sizes and styles, we are also here to serve your imagination. With our access to the finest building materials, if you can dream it we can build it for you.

** Using finger-jointed pieces conserves wood resources, reduces potential for warping and bow, and helps prevent checking or cracking of finished surfaces.*





TURNCRAFT®

Beauty. Value. Performance.

Turncraft's long history of high-quality craftsmanship is reflected in its entire product line, designed to add elegance and value to any building project.

Turncraft is your best source for:

- Poly-Classic® FRP Columns
- Poly-Classic® DuraGlass™ Columns
- Poly-Classic® Craftsman Series Columns
- Poly-Classic® Poly-Vinyl Porch Posts
- Turncraft Architectural Columns
- Wood Colonial Columns
- Wood Square Columns
- Wood Porch Posts

For detailed information on Turncraft's complete product line, please visit our website

Turncraft.com

PO Box 2429
White City, Oregon 97503
T 541 826 2911
F 541 826 1393
info@turncraft.com

distributed by:

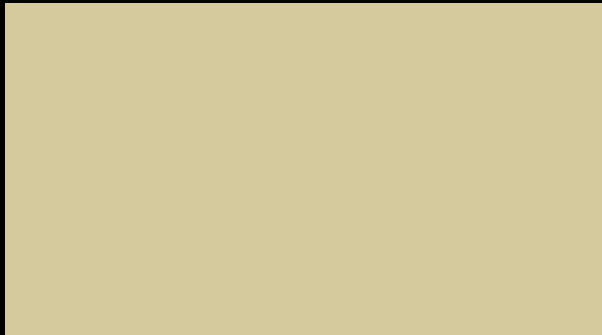

©2020 Turncraft. All rights reserved. Turncraft and Poly-Classic® are registered trademarks of Cascade Wood Products, Inc. Post Defense™ is a trademark of Cascade Wood Products, Inc. All other trademarks mentioned herein are the property of their respective owners. Information and specifications in this catalog are subject to change without notice.

